



Installation and operating instructions

intelligent paperless recorder DS400



Including

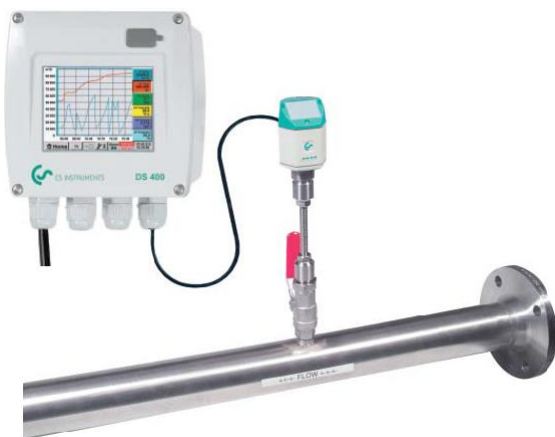

Short-form instruction manual
flow station



Short-form instruction manual
dew point set

I. Foreword

Dear customer,

thank you very much for deciding in favour of the DS 400. Please read this installation and operation manual carefully before mounting and initiating the device and follow our advice. A riskless operation and a correct functioning of the DS 400 are only guaranteed in case of careful observation of the described instructions and notes



Sales Office South / Geschäftsstelle Süd

Zindelsteiner Str. 15

D-78052 VS-Tannheim

Tel.: +49 (0) 7705 978 99 0

Fax: +49 (0) 7705 978 99 20

Mail: info@cs-instruments.com

Web: <http://www.cs-instruments.com>

Sales Office North / Geschäftsstelle Nord

Am Oker 28c

D-24955 Harrislee

Tel.: +49 (0) 461 700 20 25

Fax: +49 (0) 461 700 20 26

Mail: info@cs-instruments.com

Web: <http://www.cs-instruments.com>

Table of Contents

II. Table of Contents

1	Safety instructions.....	6
1.1	General.....	6
1.2	Installation	7
2	Short-form instruction manual Flow station DS 400	9
2.1	Connection diagram for DS 400 with “VA 400”	9
2.2	Connection diagram for DS 400 with VA 500	9
3	Short-form instruction manual dew point set DS 400	10
3.1	Connection diagram for DS 400 with FA 410	10
3.2	Connection diagram for DS 400 with FA 510	10
3.3	Dew point set DS 400 with FA 410 with alarm unit (option).....	11
4	Application area	12
5	Intended use.....	12
6	Technical data DS 400	13
7	Input signal.....	14
8	Cable cross-section.....	14
8.1	Power supply 100 - 240 VAC, 50 - 60 Hz, special version 24 VDC:	14
8.2	Sensor circuit points/Output signal:.....	14
9	Panel / Wall mounting.....	15
10	Connection diagrams DS 400	17
10.1	Connections Inputs „A1 – B2“ (Analog- und Digital-Channels)	17
10.2	Connection input „D“ (galv. isolated Impulse output / Impulse signal forwarding support pins).....	18
10.2.1	Basic version (Support pins for impulse forwarding)	18
10.2.2	Option gal. isolated impulse.....	18
10.3	Connection input „E“ (RS485 -- Modbus) (Slave Output).....	18
10.4	Connection inputs „A - C“ Power supply and 2x Alarmrelais.....	19
11	Connection diagrams of the different sensor types.....	20
11.1	Connection for CS dew point sensors Series FA 415 / FA 300	20
11.2	Connection for dew point- and consumption sensors, series FA/VA 400	21
11.3	Connection for dew point- and consumption sensors, series FA/VA 5xx	21
11.4	Connection pulse sensors	22
11.5	Analogue two-, three-, and four-wire current signal	23
11.6	Three- and four-wire power supply 0 - 1/10/30 VDC	26
11.7	Two-, three-, and four-wire connector pin assignments for PT100/PT1000/KTY81	27
11.8	Connection with RS485	27

Table of Contents

12	Connect the DS 400 with a PC	28
13	Operation DS 400.....	29
13.1	Main menu (Home).....	29
13.1.1	Initialization	29
13.1.2	Main menu after initialization	30
13.2	Settings	31
13.2.1	Password-Settings	31
13.2.2	Sensor-Settings	32
13.2.2.1	Choice of the sensor type (For example type CS-Digital sensor)	32
13.2.2.2	Name the measurement data and define the decimal places	34
13.2.2.3	Recording measurement data	34
13.2.2.4	Alarm-Settings	35
13.2.2.5	More Settings (scale analogue output).....	37
13.2.2.6	Dew Point Sensor FA 400 / FA 410 of type CS-Digital (SDI Bus).....	38
13.2.2.7	Flow sensor VA 400 / VA 420 of type CS-Digital (SDI Bus).....	39
13.2.2.8	Dew Point Sensor FA 500 / FA 510 of type FA 5xx (RS 485 Modbus)	42
13.2.2.8.1	Settings Dew point sensor FA 500 FA 510	43
13.2.2.8.2	Unit selection for temperature and humidity	43
13.2.2.8.3	Definition of the System pressure (relative pressure value).....	43
13.2.2.8.4	Definition of Reference pressure (absolute pressure value)	44
13.2.2.8.5	Calibration.....	45
13.2.2.8.6	More Settings Analogue output 4-20mA	45
13.2.2.9	Flow sensor of type VA 5xx (RS 485 Modbus).....	46
13.2.2.9.1	Settings for Flow sensor VA 5xx	47
13.2.2.9.2	Settings analogue output 4-20mA of VA 5xx.....	51
13.2.2.9.3	Settings Pulse / Alarm output of VA 5xx.....	52
13.2.2.9.4	Settings ZeroPoint or Low Flow Cut off for VA 5xx	54
13.2.2.10	Configuration of Analog-Sensors	55
13.2.2.10.1	Type 0 - 1/10/30 Volt und 0/4 – 20 mA.....	55
13.2.2.10.2	Type PT100x and KTY81	57
13.2.2.10.3	Type Pulse (Pulse ration)	58
13.2.2.10.4	Type „No Sensor“	60
13.2.2.11	Type Modbus	61
13.2.2.11.1	Selection and activation of Sensor-Type Modbus	61
13.2.2.11.2	Modbus Settings	61
13.2.2.12	Custom Sensor	65
13.2.2.12.1	Sensor settings saving	65
13.2.2.12.2	Sensor settings import.....	66
13.2.3	Device Settings	67
13.2.3.1	Language.....	67
13.2.3.2	Date & Time.....	68
13.2.3.3	Network-Settings	69
13.2.3.4	ModBus (Slave)	70
13.2.3.5	Relay Settings	71
13.2.3.6	SD-Card.....	72
13.2.3.7	System.....	73
13.2.3.7.1	Save system settings.....	73
13.2.3.7.2	System update.....	73
13.2.3.7.3	Check for Updates	74
13.2.3.7.4	Update Firmware	74
13.2.3.7.5	Update Channels	74
13.2.3.7.6	Factory Reset	75
13.2.3.8	Calibrate touch-screen	76
13.2.4	Set backlight	76
13.2.5	Cleaning.....	77
13.2.6	System-Status.....	77
13.2.7	About DS 400.....	77

Table of Contents

13.2.8	Virtual Channels (optional)	78
13.2.8.1	Option „Virtual Channels“ activation	78
13.2.8.2	Virtual Channels Einstellung	79
13.2.8.3	Selection of Sensor-type	79
13.2.8.4	Configuration of each single virtual value	80
13.2.8.4.1	Activation of a single virtual value	80
13.2.8.4.2	Definition of Operands	80
13.2.8.4.3	Definition of Operations	82
13.2.8.4.4	Definition of Unit	82
13.2.8.5	Value name, resolution of decimal places and recording of values	84
13.2.8.6	Calculation Example „Specific Performance“	85
13.2.9	Analog Total (optional)	87
13.2.9.1	Option „Analog Total“ activation	87
13.2.9.2	Selection of sensor type	88
13.2.10	Webserver (optional)	89
13.2.10.1	Option „Webserver“ activation	89
13.2.10.2	Setup the Webserver Admin Password	90
13.2.10.3	Webserver start	90
13.2.10.4	Webserver assignment of rights (Administrator)	91
13.2.10.4.1	Accessrights Webserver	91
13.2.10.5	Webserver Login	91
13.2.10.6	New users and password	92
13.2.10.7	Webserver E-Mail Configuration (Administrator)	92
13.2.10.8	Webserver MailOnAlarm (Administrator & Operator)	94
13.2.10.9	Webserver Chart (Administrator, Operator & User)	95
13.2.10.10	Webserver Screen	96
13.2.10.11	Webserver Actuals	97
13.2.10.12	Webserver Status	97
13.2.11	Data Logger (optional)	98
13.2.11.1	Option „Data Logger“ activation	98
13.2.11.2	Data logger Settings	98
13.3	Chart	102
13.4	Chart / Real time values	106
13.5	Channels	108
13.6	Real time values	109
13.7	Alarm-Overview	110
13.8	Export /Import	111
13.8.1	Export Logger data	111
13.8.2	Export System Settings	113
13.8.3	Import System Settings	114
13.9	Screenshot function	115
13.9.1	Screenshot saving	115
13.9.2	Screenshots export	116
14	Cleaning	118

1 Safety instructions

1.1 General



Please check whether this manual corresponds with the device type.

Please attend to all notes indicated in this instruction manual. It contains essential information which has to be followed during installation, operation and maintenance. Therefore, this instruction manual has to be read categorically by the technician as well as by the responsible user/qualified personnel before installation, initiation and maintenance.

This instruction manual has to be available at any time at the operation site of the DS 400.

Regional and national regulations respectively, have to be observed in addition to this instruction manual if necessary.

In case of any obscurities or questions with regard to this manual or the instrument please contact CS Instruments GmbH.



Warning!

Inadmissible operating parameters!

Undercutting and exceeding respectively of limit values may cause danger to persons and material and may lead to functional and operational disturbances.

Measures:

- Make sure that the DS 400 is only operated within the admissible limit values indicated on the type label.
- Strict observance of the performance data of the DS 400 in connection with the application.
- Do not exceed the admissible storage and transportation temperature.

Further safety instructions:

- Attention should also be paid to the applicable national regulations and safety instructions during installation and operation.
- The use of the DS 400 in explosive/hazardous areas is not allowed.

Additional remarks:

- Do not overheat the instrument!
- Change of battery and SD-Card are only allowed to be carried out by authorized qualified personnel and in strain less state



Attention!

Malfunctions at the DS 400!

Faulty installation and insufficient maintenance may lead to malfunctions of the DS 400 which may affect the measuring results and which may lead to misinterpretations.

1.2 Installation



Warning!

Supply voltage!

Contact with supply voltage carrying non-insulated parts may cause an electric shock with injury and death.

Measures:

- Note all applicable regulations for electrical installations (e.g. VDE 0100)!
- **Carry out maintenance only in strain less state!**
- All electric works are only allowed to be carried out by authorized qualified personnel.



Danger!

Missing earth connection!

When the earth connection (protective earth) is missing, there is the risk in the event of malfunction, that contactable, conductive components may carry supply voltage. Touching of such parts leads to an electric shock with injuries and death.

It is imperative to connect the plant to earth or to connect the protective conductor according to the regulations.

Do not use plug adapters at the power plug.

Have the power plug replaced by qualified skilled persons, if required.

Safety Instructions

The plug of the power supply cord is used as a separator. This separator must be clearly recognizable and easily accessible by the user. A plug connector with a CEE7/7 system is necessary.

All the electrical lines carrying supply voltage or another voltage that is dangerous in the case of contact (power supply cord, alarm and indicator relays), must additionally be equipped with double or reinforced insulation (EN 61010-1). This can be ensured by using plastic-sheathed cables, a second insulation (e.g. flexible insulating tubing), or correspondingly suitable lines with reinforced insulation. The connecting cables can be equipped, for example, with flexible insulating tubing.

The additional flexible insulating tubing must withstand the electrical and mechanical stresses which can occur during the intended use (see EN 61010-1, Clause 6.7.2.2.1).



DANGER! **Supply voltage!**

When wiring the connecting lead, it must be ensured that the double or reinforced insulation between the electric circuits that are dangerous in the case of contact and the contactable secondary circuit remains maintained.



NOTE!

The additional insulation must be suitable for a test voltage of 1500 V alternating current.

The thickness of the insulation must be at least 0.016 inch.
E.g. flexible insulating tubing, type BIS 85 (Bierther GmbH).

The additional insulation of the connecting leads (mains connection, alarm and indicator relays) can be implemented as follows:



- (1) - Terminals (connectors)
- (2) - Flexible insulating tubing for the connecting leads
- (3) - Connecting cable

2 Short-form instruction manual Flow station DS 400

2.1 Connection diagram for DS 400 with “VA 400”

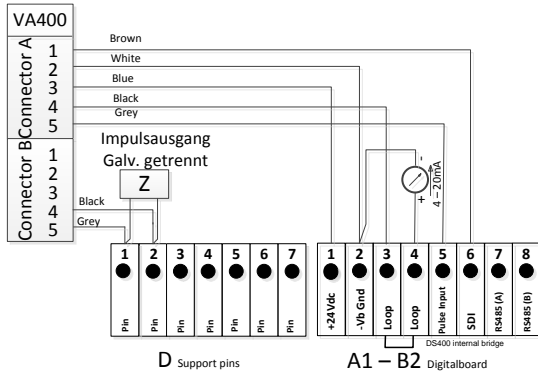

Standard Version

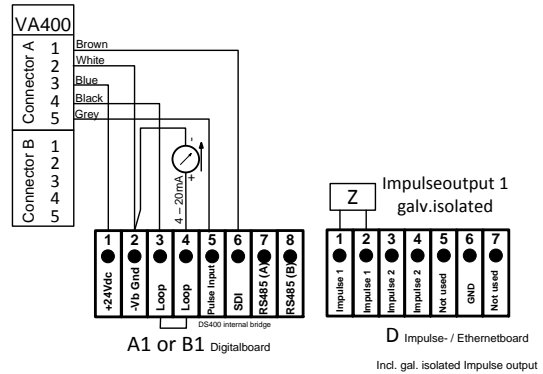

With „Ethernet“ (galv. Isolated Impulse output intr. on Ethernet PCB)

2.2 Connection diagram for DS 400 with VA 500

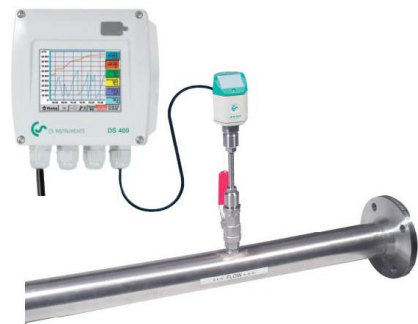
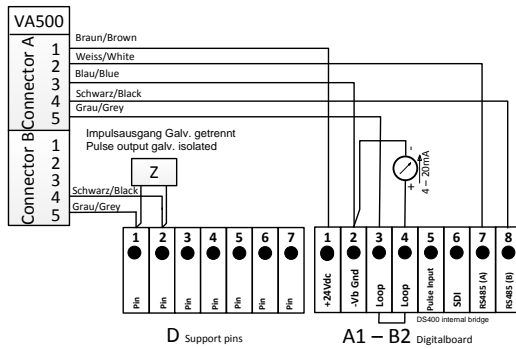

Mounting depth

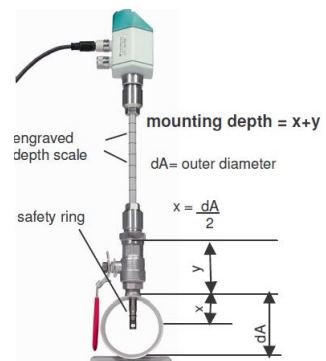

Please read carefully before starting the device!

1. Do not exceed pressure range > 50 bar
 2. Observe flow direction of the sensor
 3. Adapter sleeve must be tightened with a torque of 20-30 Nm
 4. Observe minimum values for the inlet section (15 x inner diameter) and for the outlet section (5 x inner diameter)
- For further information please see instruction manual VA 400.

Necessary adjustments (see chapter [12.2.2 Sensor settings](#))

- Adjust inner diameter of the pipe (menu sensor adjustment/consumption)
DS400 automatically scales the analogue output 4...20 mA to the respective values for m³/h, m³/min and so on.
- Reference temperature and reference pressure (factory setting 20 °C, 1000 hPa):
All volume flow values (m³/h) and consumption values indicated in the display are related to 20 °C, 1000 hPa (according to ISO 1217 intake condition)
0 °C and 1013 hPa (=standard cubic meter) can also be entered as a reference.
Do not enter the operation pressure or the operation temperature under reference conditions!

Shortform instructions

3 Short-form instruction manual dew point set DS 400

3.1 Connection diagram for DS 400 with FA 410

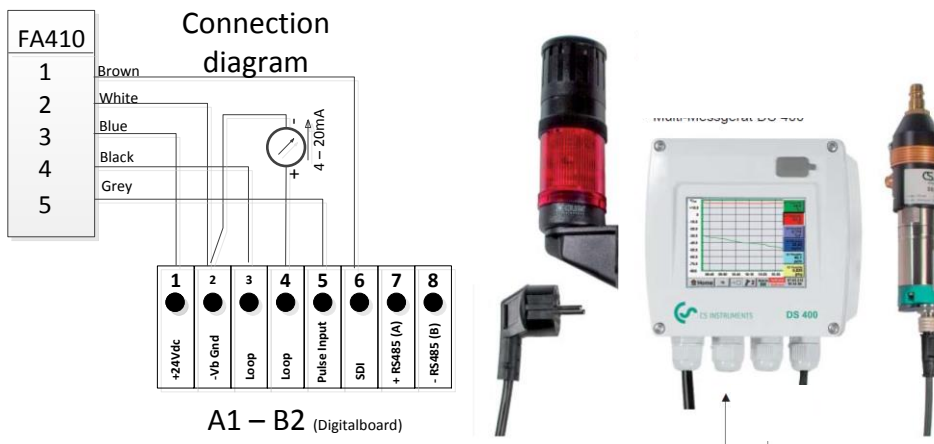

3.2 Connection diagram for DS 400 with FA 510

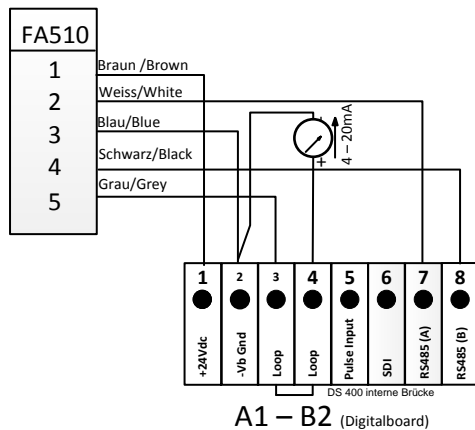

Power supply alarm connection:

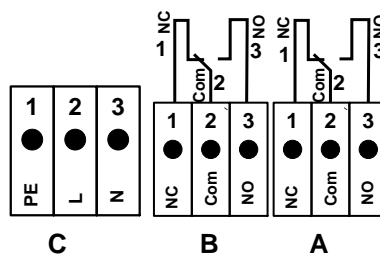

NC and COM are connected at:

- alarm
- power failure
- sensor break



Please read carefully before starting the device!

1. Attention: Do not exceed pressure range of > 50 bar with standard version. (Up to 350 bar in case of special version).
2. Important: Before installation briefly bleed the compressed air in order to remove condensate and particles. This prevents soiling of FA 410. Standing air leads to long measuring times.

Shortform instructions

3.3 Dew point set DS 400 with FA 410 with alarm unit (option)

- Dew point set ready for plug in and fully configured, no further adjustments necessary.

- Alarm values are programmed on our premises:

Dew point set -20...+50 °Ctd to alarm 1: 8 °Ctd, alarm 2: 12 °Ctd

Dew point set -80...+20 °Ctd to alarm 1: -40 °Ctd, alarm 2: -35 °Ctd

in case of alarm unit option: Alarm 1 continuous red light

Alarm 2 buzzer

The alarm values can easily be changed within the DS 400

(Settings → Sensor settings → A1 → Alarm see also chapter [12.2.2.4 Alarm-Settings](#)).

Connection diagram Option alarm unit

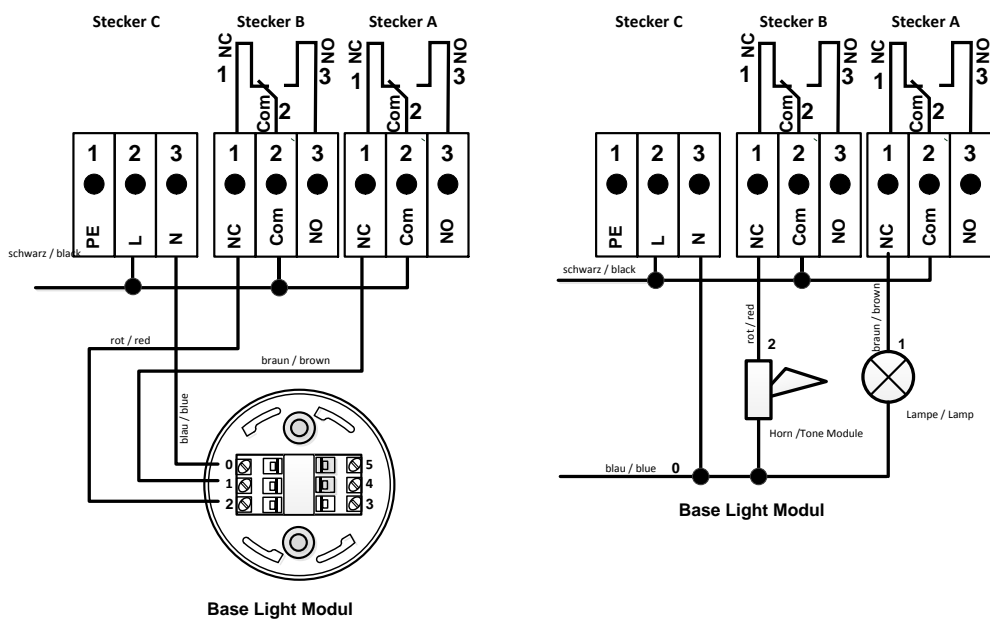

4 Application area

Our long-term hands-on experience in measurement and control technology was implemented in the new DS 400.

From recording of the measured data, automatic sensor identification, indication on a big colour screen, alerting, storage up to remote read-out via web server, all that is possible with DS 400. By means of the CS-Soft, software alarms can be sent via SMS or e-mail.

On the big 3.5' colour screen with touch panel all information is available at a glance. The operation is very easy. All measured values, measured curves and threshold exceedings are indicated. The progression of the curve, since the beginning of the measurement, can be viewed by an easy slide of the finger.

The huge difference to ordinary paperless chart recorders reveals in the easy initiation as well as in the evaluation of the measured data. All sensors are identified directly and powered by DS 400. Everything is matched and tuned.

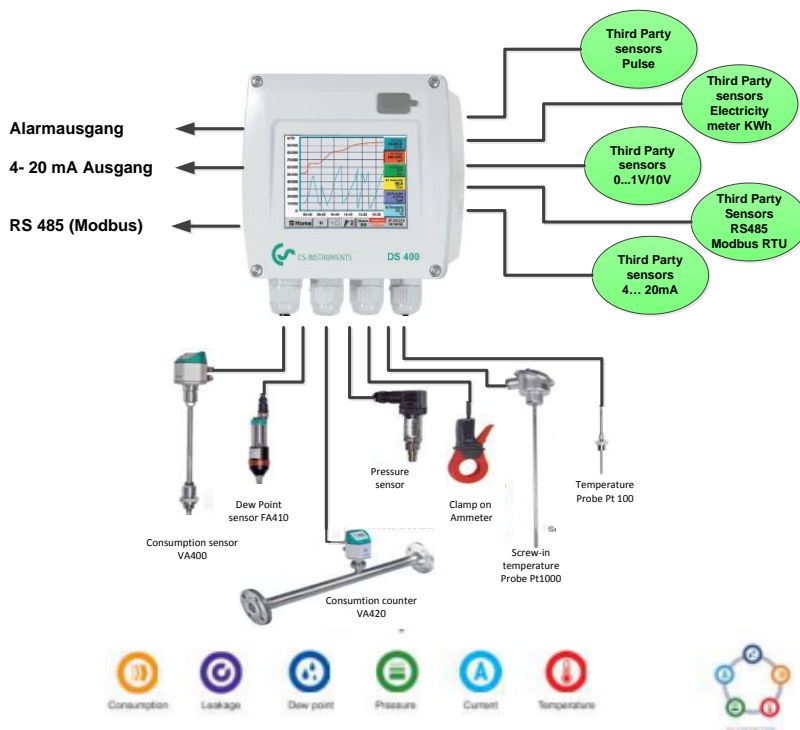

Versatile:

Up to 4 sensors, incl. all CS sensors (consumption, dew point, pressure, current, KTY, PT 100, PT 1000) are identified automatically by DS 400. Optional analogue sensors (0/4 - 20 mA, 0 - 1/10/30 V, pulse) can be configured easily and quickly. Digital sensors can be connected via RS 485 Modbus RTU and SPI.

Flexible:

Network-compatible and worldwide remote data transmission via Ethernet, integrated web server.

Alarm relay / fault indication:

Up to 4 threshold values can be configured freely and allocated to 2 different alarm relay. Collective alarms are possible.

5 Intended use

The DS 400 data logger serves for the stationary measured data acquisition and storage of analogue and digital input signals.

The DS 400 data logger is exclusively designed and constructed for the proper application purpose that is described herein and must only be used correspondingly.

A check in order to ascertain whether or not the device is suitable for the chosen employment must be carried out by the user. It must be ensured that the medium is compatible with the components which come into contact with it. The technical data listed in the data sheet are binding.

Improper handling or operation outside the technical specifications is impermissible. Claims of any kind on the basis of improper use are excluded.

6 Technical data DS 400

Dimensions of housing	118 x 115 x 98 mm
Connections	5 x PG12 for sensors and supply, alarm relay 1 x RJ 45 Ethernet connection
Version panel mounting	Cutout panel 92 x 92 x 75 mm
Weight	545 g
Material	Plastic , Frontfolie Polyester
Protection level	IP44
Sensor inputs	4 (2x2) sensor inputs for analogue and digital sensors freely allocable. Digital CS sensors for dew point and consumption with SDI interface FA/VA 400 Series. Digital third-party sensors RS 485/Modbus RTU, other bus systems realizable on request. Analogue CS sensors for pressure, temperature, clamp-on ammeters preconfigured. Analogue third-party sensors 0/4 – 20 mA, 0 - 1/10/30 V, pulse, Pt100/Pt1000, KTY.
Power supply for sensors	Output voltage:: 24 VDC \pm 10% Output current: a.) Digital-Board 120mA continuous operation / channel b.) Analog-Board 120mA continuous operation for both channels Maximum output current over all channels: 280mA
Interfaces	USB stick USB 2.0), Ethernet TCP RS 485 Modbus RTU, SDI (Serial data Interface) other bus systems on request, web server optional
Outputs	Outputs 2 relay (max. switching voltage: 230 VAC / 30 VDC, Switching current: min. 10mA, max. 3A) alarm management, Relay freely programmable, collective alarm. Analogue output, pulse in case of sensors with own signal output looped, like e.g. VA/FA Series.
Power supply	100 – 240 VAC/50 – 60 Hz, max.power input: 23VA, special version 24 VDC
Battery ¹⁾	CR 2032
Colour screen	3.5"-Touchpanel TFT transmissive, graphics, curves, statistics
Accuracy	See sensor specifications
Operating temperature	0 – 50 °C
Storage temperature	-20 bis +70°C
Data Logger Memory size 4 GB SD memory card (micro SD class4)	Optional
Ethernet- and RS 485 Interface (Modbus Protocol)	Optional
Webserver	Optional
Galv. Isolated Impulse output (2x)	Optional

¹⁾ Lithium manganese dioxide battery, Panasonic CR2032 / 3 V / 225 mAh

7 Input signal

Input signal		
Current signal (0 – 20 mA / 4 – 20 mA) internal or external power supply	Measuring range	0 – 20 mA / 4 – 20 mA
	Resolution	0,0001 mA
	Accuracy	$\pm 0,003 \text{ mA} \pm 0,05 \%$
	Input resistance	50 Ω
Voltage signal (0 - 1V)	Measuring range	0 - 1 V
	Resolution	0,05 mV
	Accuracy	$\pm 0,2 \text{ mV} \pm 0,05 \%$
	Input resistance	100 k Ω
Voltage signal (0 - 10 V / 30 V)	Measuring range	0 - 10 V/30 V
	Resolution	0,5 mV
	Accuracy	$\pm 2 \text{ mV} \pm 0,05 \%$
	Input resistance	1 M Ω
RTD Pt100	Measuring range	-200 - 850 °C
	Resolution	0,1 °C
	Accuracy	$\pm 0,2 \text{ °C}$ at -100 - 400 °C $\pm 0,3 \text{ °C}$ (further range)
RTD Pt1000	Measuring range	-200 - 850 °C
	Resolution	0,1 °C
	Accuracy	$\pm 0,2 \text{ °C}$ at -100 - 400 °C $\pm 0,3 \text{ °C}$ (further range)
Pulse	Measuring range	minimal pulse length 100 μs frequency 0 - 1 kHz max. 30 VDC

8 Cable cross-section

8.1 Power supply 100 - 240 VAC, 50 - 60 Hz, special version 24 VDC:

Cable cross section power supply: 0,75 mm²

8.2 Sensor circuit points/Output signal:

AWG16 – AWG28, cable cross-sections: 0,14 - 1,5 mm²

Cable gland clamping Range: 4-8mm

9 Panel / Wall mounting

The instrument can either be mounted into a panel or - if ordered with the optional wall casing - on a wall. Please refer to the drawings below for details.

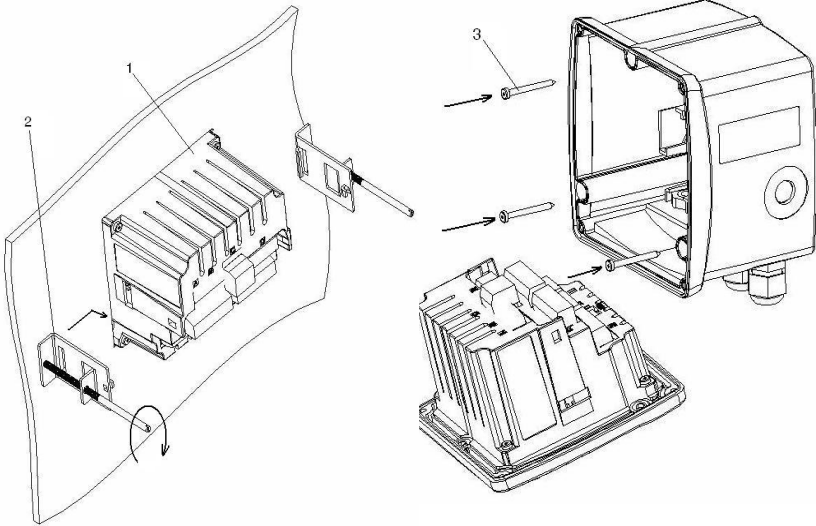

Figure: Panel and wall mountable housing

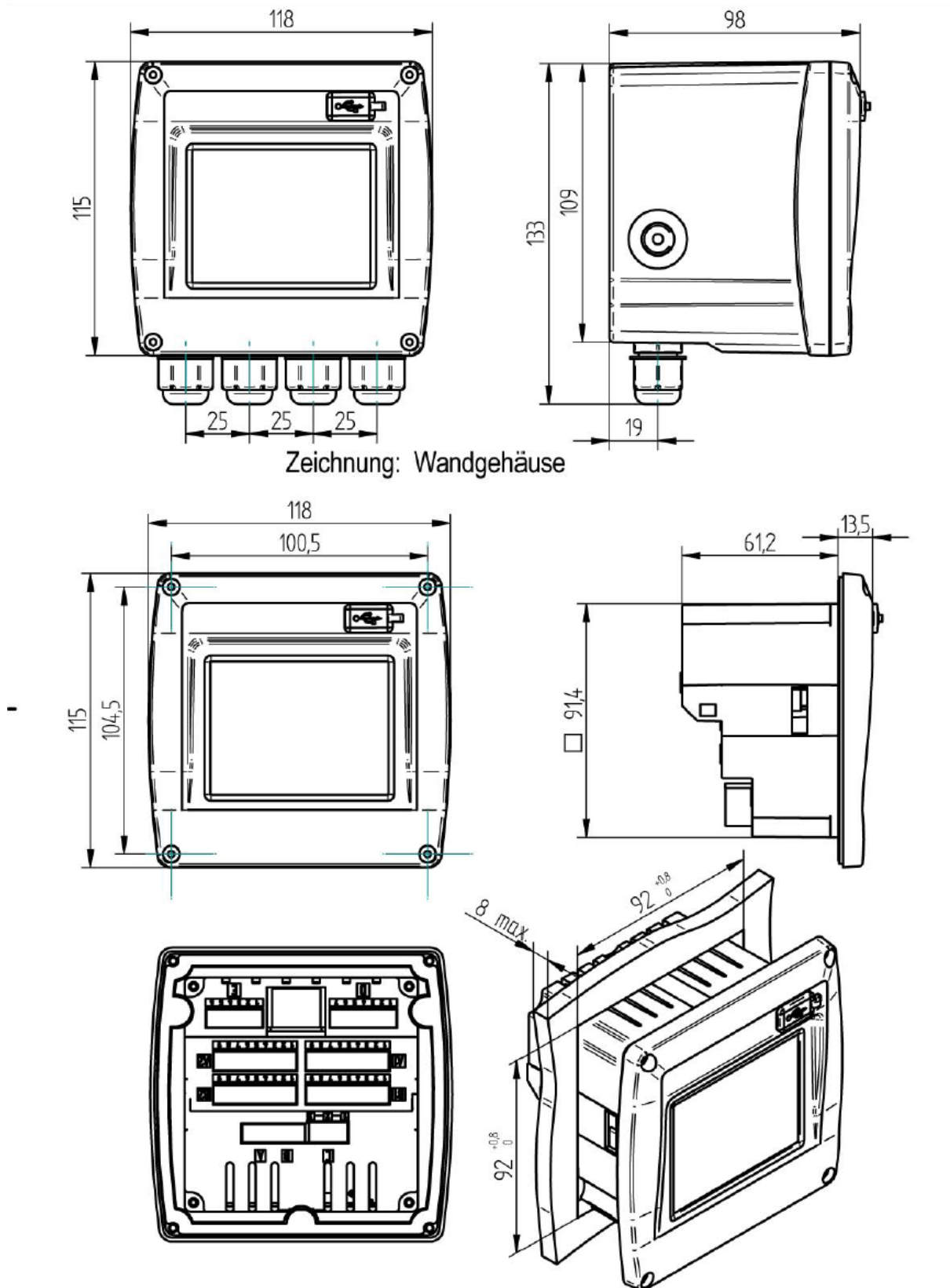
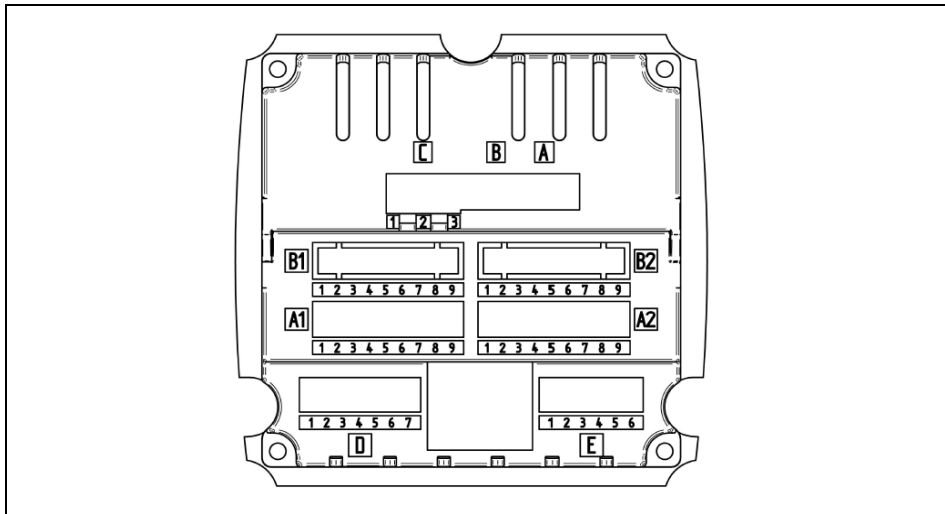
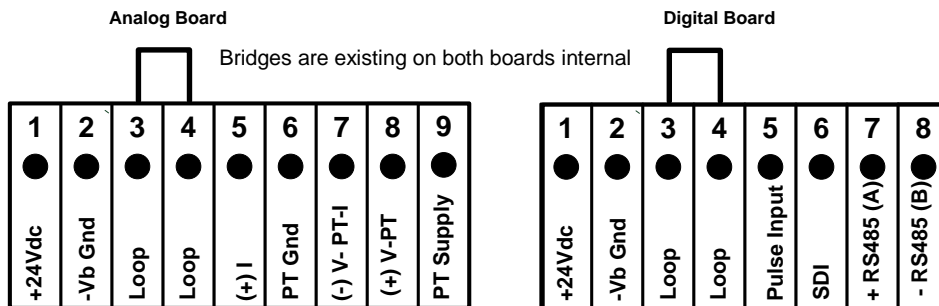

Figure : Housing for panel mounting

10 Connection diagrams DS 400



10.1 Connections Inputs „A1 – B2“ (Analog- und Digital-Channels)



Depending on selected variant following combinations are possible:

combination \ Channel	1	2	3	4	5	6
A1	D	D	D	A	A	A
A2	D	D	D	A	A	A
B1		D	A		A	D
B2		D	A		A	D

D = Digital-Channel A = Analog-Channel

Connection diagrams DS 400

10.2 Connection input „D“ (galv. isolated Impulse output / Impulse signal forwarding support pins)

10.2.1 Basic version (Support pins for impulse forwarding)

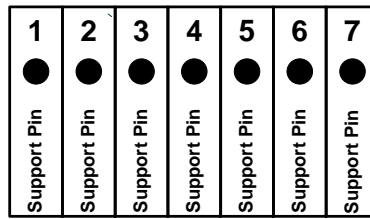

10.2.2 Option gal. isolated impulse

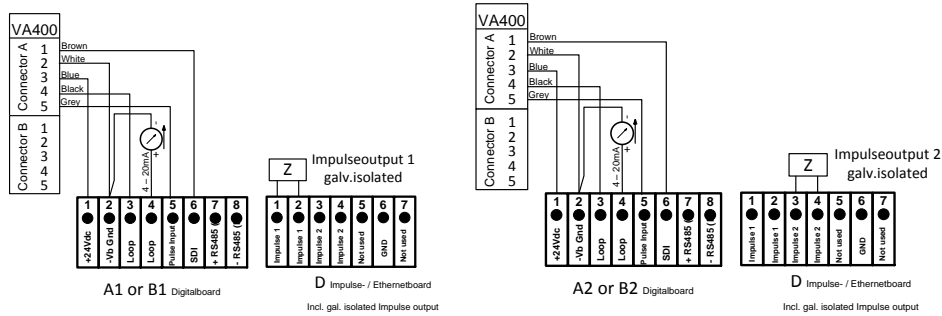

For systems with 2 digital boards (2x2 digital channels) on pulse output 1 could be used either pulse input A1 or B1, as well as for pulse output 2 either pulse input A2 or B2.

It is not possible pulse to switch pulse input A1 or B1 on pulse output 2 or pulse input A2 or B2 on pulse output 1.

Parallel wiring of the pulse inputs A1 and A2 u.B1 u.B2 is not allowed.

10.3 Connection input „E“ (RS485 -- Modbus) (Slave Output)

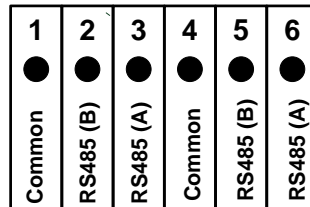

10.4 Connection inputs „A - C“ Power supply and 2x Alarmrelais

Power supply: 90 - 260 VAC 50 – 60 Hz
 2 x Alarm relays, max. 230VAC, 3A

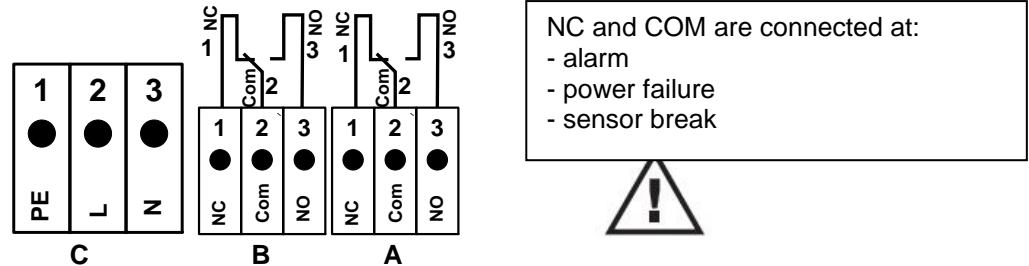

DANGER!
Supply voltage!

When wiring the connecting lead, it must be ensured that the double or reinforced insulation between the electric circuits that are dangerous in the case of contact and the contactable secondary circuit remains maintained.



NOTE!

The additional insulation must be suitable for a test voltage of 1500 V alternating current.
 The thickness of the insulation must be at least 0.016 inch.
 E.g. flexible insulating tubing, type BIS 85 (Bierther GmbH).

The additional insulation of the connecting leads (mains connection, alarm and indicator relays) can be implemented as follows:



- (1) - Terminals (connectors)
- (2) - Flexible insulating tubing for the connecting leads
- (3) - Connecting cable

Connection diagrams of the different sensor types

11 Connection diagrams of the different sensor types

By/With consumption sensors and dew point sensors from CS Instruments there is the possibility to provide values as analogue current signal 4 – 20 mA for further working process. The measurement/reading of the current signal for an external PLC/ZLT or external third-party display is explained in the connection diagrams.

BY using of the CS Instruments connection cables 0553.0104 or 0553.0105 please follow pinning

	Pin 1	Pin 2	Pin 3	Pin 4	Pin 5
Connection cable	brown	white	blue	black	grey
Connector (A) VA400	SDI	- VB	+ VB	+I (4-20mA)	NC* pulse active not galv. isolated
Connector (A) VA400	SDI	- VB	+ VB	+I (4-20mA)	NC*
Connector FA400/410	SDI	- VB	+ VB	+I (4-20mA)	NC*
Connector FA415/416	SDI	- VB	+ VB	NC*	NC*

* NC = Not Connected

The following connection diagrams in Chapter 10 apply to A1 to B2!

FA serial: dew point sensors from CS Instruments

VA serial: consumption sensors from CS Instruments

11.1 Connection for CS dew point sensors Series FA 415 / FA 300

<p>Digitalboard</p>	<p style="text-align: center;">DS 400</p> <p>The digital data transmission between DS 400 and the dew point sensors FA 415 and FA 300 occur via the SDI bus line.</p> <p>It's possible to connect the FA 300/FA 425 alternatively as 4 – 20 mA analogue sensor in 2-wire technology</p>
<p>Digitalboard</p>	<p style="text-align: center;">Connection diagram DS 400 by using analogue output 4 -20mA on external PLC/ SCADA</p> <p>Please make sure that the circuit is closed in any case</p>

Connection diagrams of the different sensor types

11.2 Connection for dew point- and consumption sensors, series FA/VA 400

<p>Digitalboard</p>	<p style="text-align: center;">DS 400</p> <p>FA 410 FA 400 VA 400 VA 420</p> <p>The digital data transmission between DS 400 and the sensors FA 400/410 and VA 400/420 occurs via the SDI bus line.</p>
<p>Digitalboard</p>	<p style="text-align: center;">Connection diagram DS 400 by using analogue output 4 -20mA on external PLC/ SCADA</p> <p>Please make sure that the circuit is closed in any case</p>

11.3 Connection for dew point- and consumption sensors, series FA/VA 5xx

<p>Digitalboard</p>	<p style="text-align: center;">DS 400</p> <p>FA 510 FA 500 VA 500 VA 520</p> <p>The digital data transmission between DS 400 and the sensors FA 500/ FA 510 and VA 500/520 occurs via RS 485 (Modbus).</p>
<p>Digitalboard</p>	<p style="text-align: center;">Connection diagram DS 400 by using analogue output 4 -20mA on external PLC/ SCADA</p> <p>Please make sure that the circuit is closed in any case</p>

Connection diagrams of the different sensor types

11.4 Connection pulse sensors

<p>Analogboard</p>		<p>signal level 0: low = 0 – 0,7 VDC</p> <p>signal level 1: high = 2,5 – 30 VDC</p> <p>t = 400 µs</p> <p>max. frequency (duty cycle 1:1) = 1000 Hz</p> <p>input resistance: min. 100 kilo ohm</p>
<p>Analogboard</p>		<p>external essential R = 4K7</p> <p>Attention: The DS 400 is counting a consumption unit, by switching „power on“.</p>
<p>Analogboard</p>		<p>external essential R = 4K7</p>
<p>Analogboard</p>		<p>It will not work!</p>

Connection diagrams of the different sensor types

11.5 Analogue two-, three-, and four-wire current signal

Sensors with 4 - 20 mA output in 2-wire technology	
<p>Diagram showing the connection of a sensor to an analog board. The sensor is connected to the (+) I terminal and the Loop terminal. The sensor has a '+' sign.</p>	<p>DS 400</p>
<p>Diagram showing the connection of a sensor to an analog board with external routing. The sensor is connected to the Loop terminal and the external PLC/SCADA 4..20 mA block. The external block has a '+' sign.</p>	<p>DS 400 with ext. 4 -20mA routing</p> <p>Please make sure that the circuit is closed in any case.</p> <p>(e.g. CS pressure sensors 1,6/16/40/100/250/400 bar or temperature sensors with integrated measuring transformer 4 - 20 mA)</p>

Connection diagrams of the different sensor types

Sensors with 4 - 20 mA output in 3-wire technology	
<p>Analogboard</p>	<p>DS 400</p>
<p>Analogboard</p>	<p>DS 400 with ext. 4 -20mA routing</p> <p>Please make sure that the circuit is closed in any case.</p>

Connection diagrams of the different sensor types

Sensors with 4 - 20 mA output in 4-wire technology	
<p>Analogboard</p>	<p>DS 400</p>
<p>Analogboard</p>	<p>DS 400 with ext. 4 -20mA routing</p> <p>Please make sure that the circuit is closed in any case.</p>

Connection diagrams of the different sensor types

11.6 Three- and four-wire power supply 0 - 1/10/30 VDC

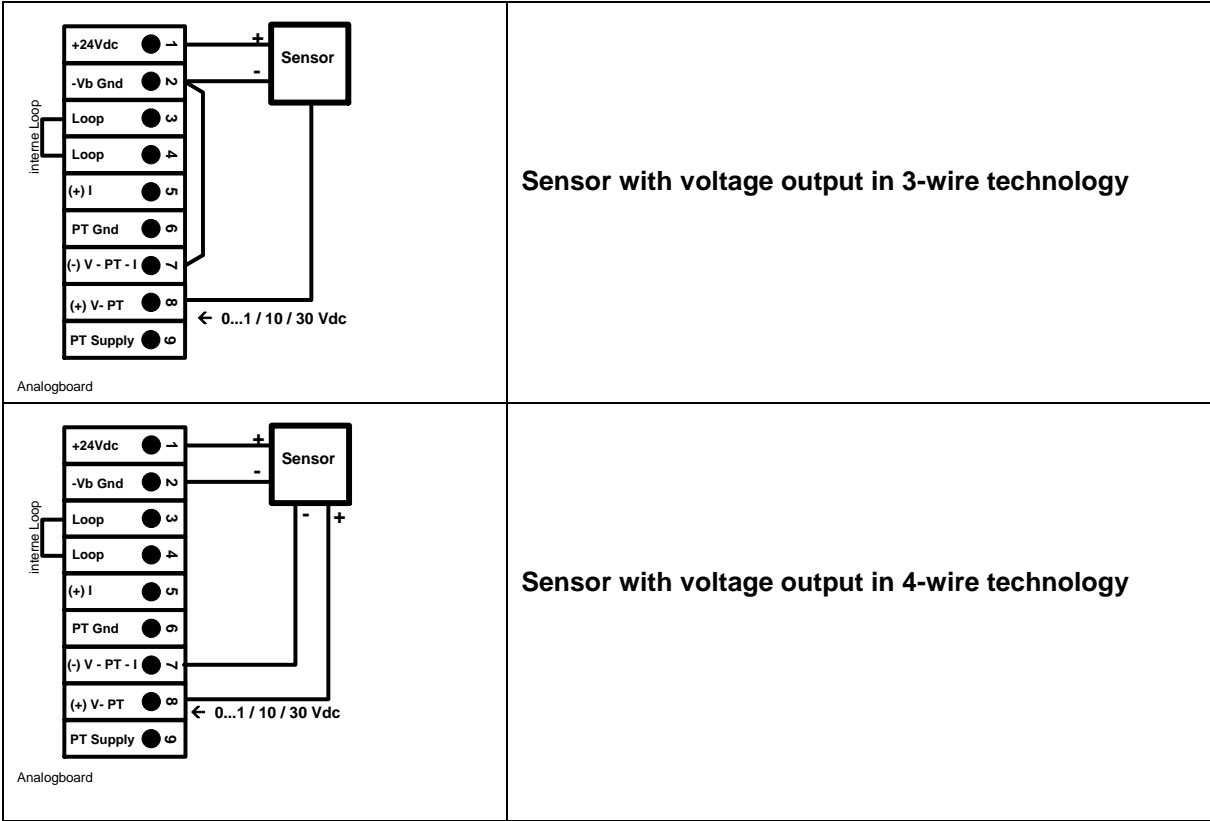

Connection diagrams of the different sensor types

11.7 Two-, three-, and four-wire connector pin assignments for PT100/PT1000/KTY81

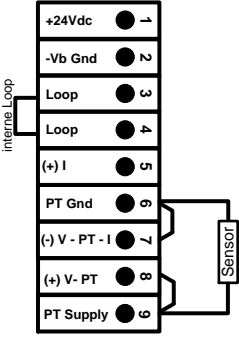
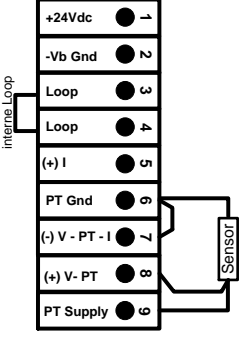
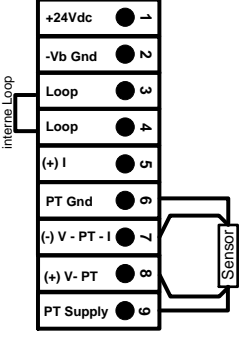
 <p>Analogboard</p>	<p>2-wire PT100/PT1000/KTY81</p>
 <p>Analogboard</p>	<p>3-wire PT100/PT1000/KTY81</p>
 <p>Analogboard</p>	<p>4-wire PT100/PT1000/KTY81</p>

11.8 Connection with RS485

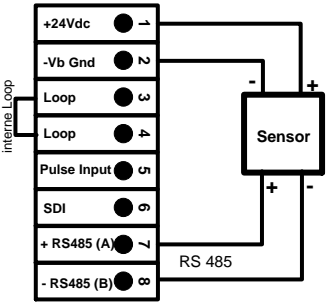
 <p>Digitalboard</p>	<p>Sensor with RS485 Interface</p>
---	---

Connect the DS 400 with a PC

12 Connect the DS 400 with a PC

Important:

The IP addresses of PC and DS 400 must be statically assigned (DHCP off) and have to be in the same network.

If the IP-address of the DS 400 has changed, you have to reboot!

Remark:

IP-address of the DS 400: See chapter, [12.2.4.3 Network-Settings](#)

Reboot the DS 400: See chapter, [12.2.3.7.6 Factory-Reset](#)

The DS 400 can be connected with the PC by a crossover cable, which has a RJ45 plug on each side, or an Ethernet cable with a crossover adapter.

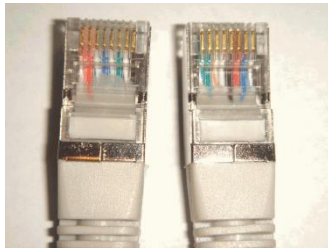

Crossover-Cable with RJ45-plug



Crossover-Adapter

After connecting the DS 400 via a suitable cable to the PC, you can make graphical and tabular data evaluations with the CS Soft Basic software.

Windows PC's, network settings:

Windows 7:

Start → Control Panel → Network and Sharing Center → adapter → Networking → Properties → Internet Protocol Version 4 (TCP/IPv4) → Use the Following IP address → enter IP address and Subnet mask

After this: OK → OK → Close

Windows Vista:

Start → Control Panel → Network and Sharing Center → Network connection → Networking → Properties → Internet Protocol Version 4 (TCP/IPv4) → Use the Following IP address → enter IP address and Subnet mask

After this: OK → OK → Close

Windows XP:

Start → Properties → Control Panel → Network connection → Networking → Properties → Internet Protocol Version 4 (TCP/IPv4) → Use the Following IP address → enter IP address and Subnet mask

After this: OK → OK → Close

13 Operation DS 400

The operation is largely self-explanatory and menu-driven via the touch panel. The selection of the respective menu items occur via short "tapping" with the finger or a soft round pen.

**Attention: Please use no pens or other objects with sharp edges!
The foil can be damaged!**

After sensors are connected, they also have to be configured.

Inputs or changes can be made with all white deposit fields. The measured values can be represented as a curve or values.

Words in **green font** refer mainly to the pictures in the section of the chapter, but also on important menu paths or menu items that are related to be in **green font**.

The menu navigation is generally in a **green font**!

The table of contents and chapter references in **blue font** contain links to the respective chapter title.

13.1 Main menu (Home)

From the main menu, you can reach every available item.

13.1.1 Initialization



After switching on the DS 400, all channels are initialized and the main menu will appear.

Attention:
For the first initiation, there may be no channels preset!

Please see chapter **12.2.2 Sensor Settings** then select appropriate configurations and set!

Main menu

13.1.2 Main menu after initialization

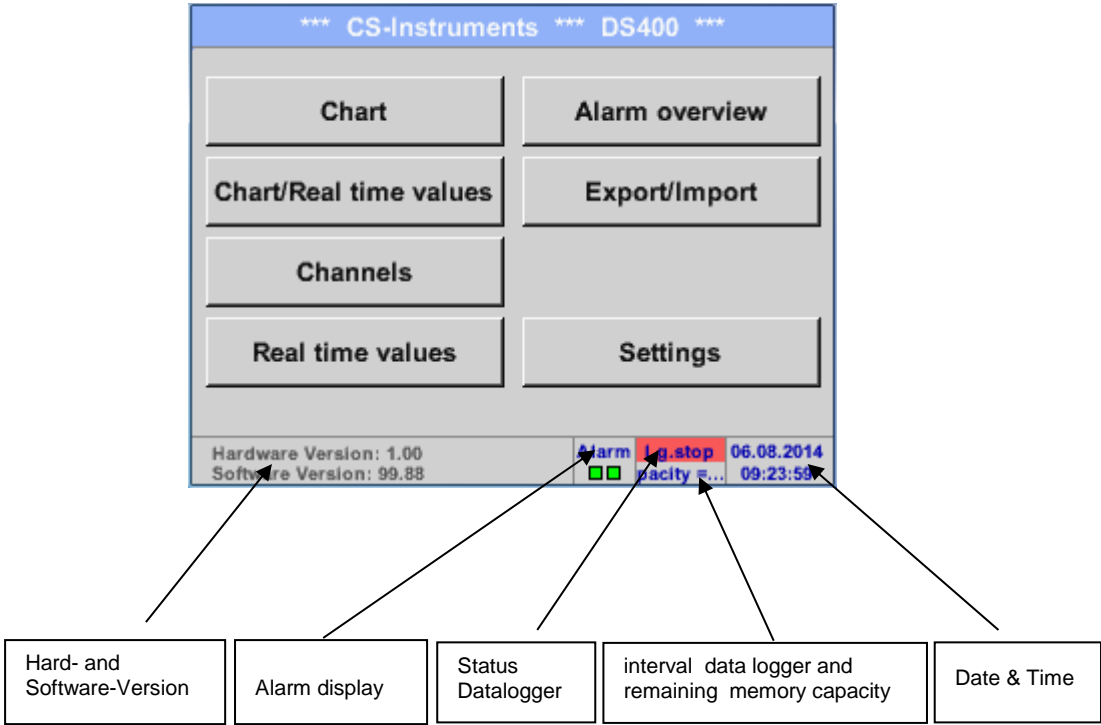

Important:
Before the first sensor setting is made, the language and time should be set!

Remark:
Chapter [12.2.4.1 Language](#)
Main → Settings → Device Settings → Set Language

Chapter [12.2.4.2 Date & Time](#)
Main → Settings → Device Settings → Date & Time

13.2 Settings

The settings are all protected by a password!

Settings or changes are generally confirmed with **OK!**

Remark:

If you go back to main menu and then again one of the setting menus is called, you must enter the password again.

Main menu → Settings

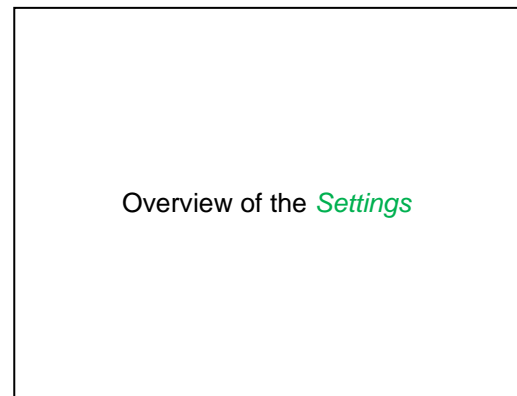

13.2.1 Password-Settings

Main menu → Settings → Password settings

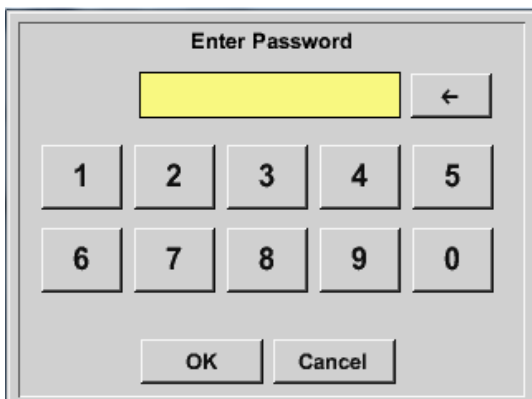

Factory settings for password at the time of delivery: 0000 (4 times zero).

If required, the password can be changed in the *Password settings*.

The new password must be entered two times in a row and in each case confirmed with **OK**

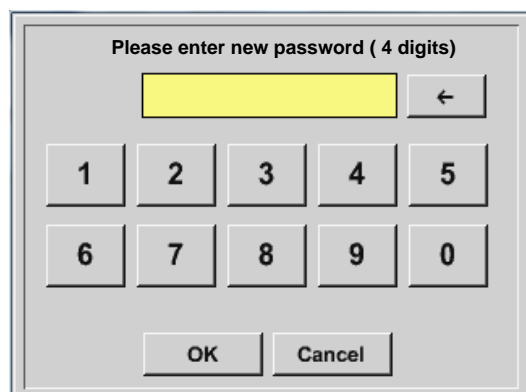

If an incorrect password is entered there appears *Enter password* or *New password repeat* in red font.

If you can't remember the password, please use Master password in order to enter a new password.

Remark:

The master password is supplied together with the instrument's documentation.

Sensor-Settings

13.2.2 Sensor-Settings

Important:

Sensors from CS Instruments are generally pre-configured and can be connected directly to a free sensor channel!

Main menu → Settings → Sensor settings

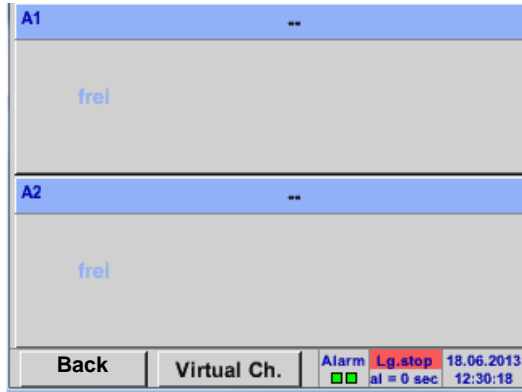

An overview of the available channels appears after entering the password. Depending on the version 2 or 4 channels.

Remark:
Usually no channels preset!

Remark:

Depending on selected variant following combinations are possible:

combination \ Channel	1	2	3	4	5	6
A1	D	D	D	A	A	A
A2	D	D	D	A	A	A
B1		D	A		A	D
B2		D	A		A	D

D = Digital-Channel A = Analog-Channel

13.2.2.1 Choice of the sensor type (For example type CS-Digital sensor)

Main menu → Settings → Sensor settings → A1



If still no sensor has been configured, the *Type No Sensor* appears.

By pushing the description field *Type No Sensor* the list of sensor types appears (see next step).

Sensor-Settings / Type CS-Digital

Main menu → Settings → Sensor settings → A1 → Type description field → CS-Digital

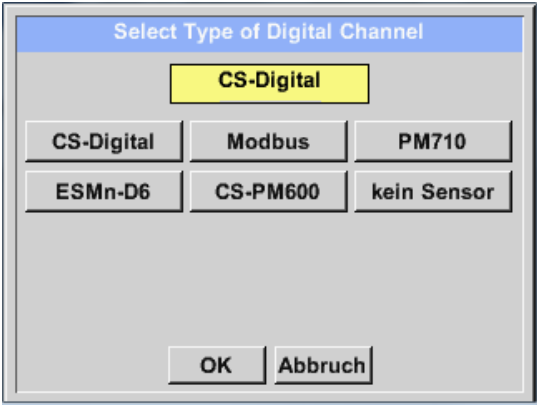

Now the *Type CS-Digital* is selected for the VA/FA 400 series and confirmed by pressing the *OK* button.

Sensor-Settings / name and recording of measurement data

13.2.2.2 Name the measurement data and define the decimal places

Remark:

The *Resolution* of the decimal places, the *Short Name* and *Value Name* are found under the **Tool button!**



Tool Button:

Main menu → Settings → Sensor settings → A1 → Tool Button

For the recorded *Value* there can be entered a *Name* with 10 characters and later in menu item *Graphics/Real time values* it is easier to identify it. Otherwise the *Name* is, for example, *A1a*. The channel name is *A1* and *a* is the first measurement data at the channel, the Second *b* and the Third *c*. The *Resolution* of the decimal places is simply adjustable by pushing right and left (0 to 5 decimal places).

See chapter [12.2.2.7 Label and setting the description fields](#)

13.2.2.3 Recording measurement data

Main menu → Settings → Sensor settings → A1 → Record Button

Use the *Record* buttons to select the measurement data that will be stored by **activated data logger**.

Attention:

Before the selected measurement data are recorded, the data logger must be activated after the settings(See chapter [12.2.1.2 Logger settings \(data logger\)](#)).

Sensor-Settings / Alarm-Settings

13.2.2.4 Alarm-Settings

Main menu → Settings → Sensor settings → A1 → → Alarm-Button

By pushing an alarm button, the following window appears:

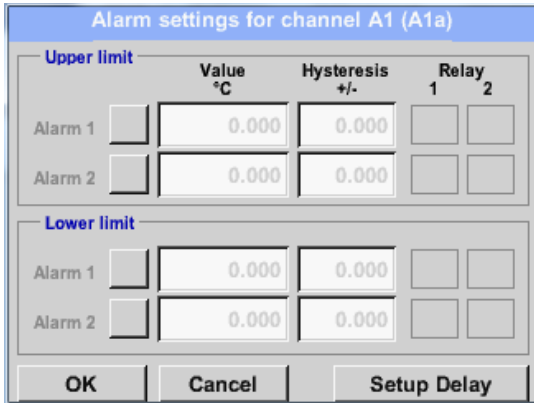

In the alarm settings an *Alarm 1* and *Alarm 2* incl. *Hysteresis* can be entered for each channel.

In the menu *Alarm overview* (can be reached from the main menu), the alarm settings are clearly represented.

Main menu → Settings → Sensor settings → A1 → → Alarm-Button → Alarm-1- und Alarm-2-buttons + Relays-buttons

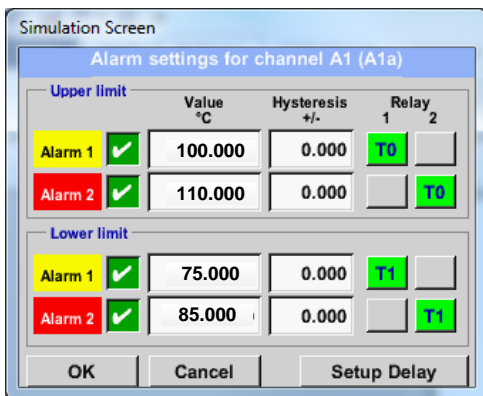

E.g. set the *Alarm 1* to relay 1 and the *Alarm 2* to relay 2.

Main menu → Settings → Sensor settings → A1 → Alarm-Button → Relay-buttons

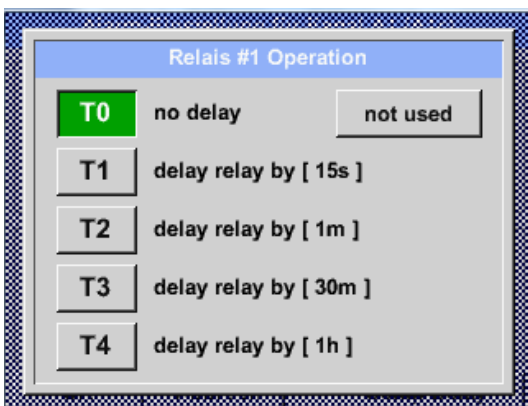

It is possible to select from 5 different delays.

T0 is preset to no delay.

The delays (T1 to T4) are free definable but are common valid for all relays.

Sensor-Settings / Alarm-Settings

Main menu → Settings → Sensor settings → A1 → Alarm-Button → Setup Delay

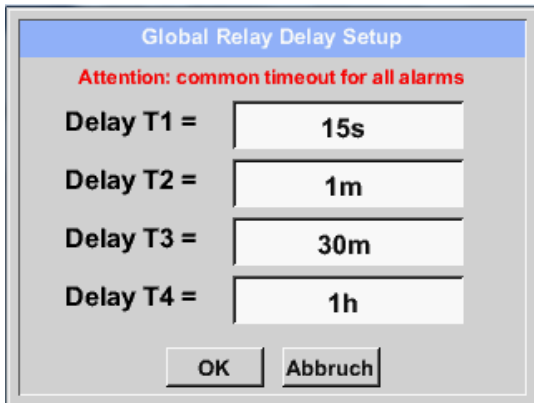

Global Relay Delay Setup

Attention: common timeout for all alarms

Delay T1 = 15s

Delay T2 = 1m

Delay T3 = 30m

Delay T4 = 1h

OK Abbruch

The delays (T1 to T4) are free definable but are common valid for all relays.

Main menu → Settings → Sensor settings → A1 → Alarm-Button → description field Delay T1

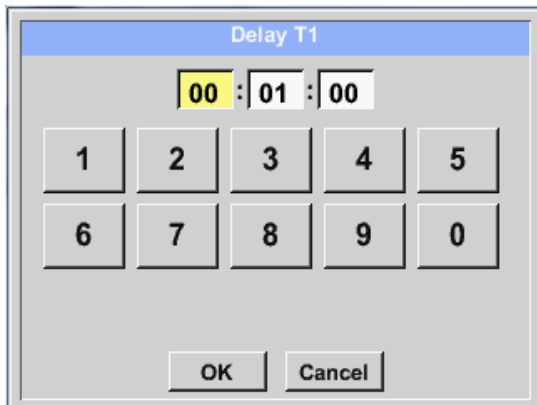

Delay T1

00 : 01 : 00

1 2 3 4 5

6 7 8 9 0

OK Cancel

By changing the text field values the new delay time could be defined. Here for *Delay T1*.

Delay T0 is preset and can't be changed and it is an immediate alarm.

Confirmation by pressing the *OK* button.

Same procedure for the remaining delay times T2-T4 is to apply.

Main menu → Settings → Sensor settings → A1



*** Channel A1 *** ~ 0.0 V
~ 0 mA

Typ CS-Digital Name Vol-1

Aufzeichnen	Alarm
<input checked="" type="checkbox"/> A1a 0,00 ltr/min	<input type="checkbox"/>
<input checked="" type="checkbox"/> A1b 2345678 ltr	<input type="checkbox"/>
<input checked="" type="checkbox"/> A1c 0,00 m/s	<input checked="" type="checkbox"/>

OK Abbruch Info

After the alarm activation at channel A1.

Remark:

After confirm with *OK*, the font is black again and the values and settings are accepted.

Sensor-Settings / More Settings (scale analogue output)

13.2.2.5 More Settings (scale analogue output)

Main menu → Settings → Sensor settings → A1 → arrow right (2.page) → More settings

More-Settings A1-Luft-1

4...20mA Output of Sensor

Base

m³/h m/s

scale manual

4mA = 0.000 m/s

20mA = -1.000 m/s

Max Velocity 92.700 m/s

Calibration Data

Gas Air (287.0)

Temperat 293.0 °K

Pressure 1000.0 hPa

Area 110.0 mm²

Cal. Date 24.07.2013

OK Cancel

In *More-Settings*, you can define whether the 4 - 20 mA analogue output of the sensor based on the flow rate or velocity.

The green highlighted description field is selected!

In addition, you can push the *scale manual* button and set the measuring range.

After confirming with *OK*, the settings are assumed.

Remark:
More-Settings only for type **CS-Digital** available!

More-Settings A1-

4...20mA Output of Sensor

Base

m³/h m/s

scale manual

4mA = 0.000 m/s

20mA = 200.000 m/s

Max Velocity 92.700 m/s

Calibration Data

Gas Air (287.0)

Temperat 293.00 °K

Pressure 1000.00 hPa

Area 110.00 mm²

Cal. Date 03.07.2013

OK Cancel

The settings finished by pushing the *OK* button!

Remark:

After confirming with *OK*, the font is black again and the values and settings are accepted.

Sensor-Settings / Dew point sensor Typ CS-Digital

13.2.2.6 Dew Point Sensor FA 400 / FA 410 of type CS-Digital (SDI Bus)

First step: choose an unused sensor channel

Main menu → Settings → Sensor settings → A1

Second step: choose type CS-Digital (inserted Digitalboard for A1/A2)

Main menu → Settings → Sensor settings → A1 → Type description field → CS-Digital

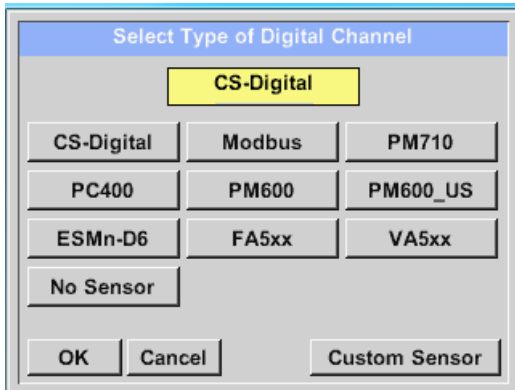

Now the *Type CS-Digital* is selected for the VA/FA 400 series and confirmed by pressing the **OK** button.

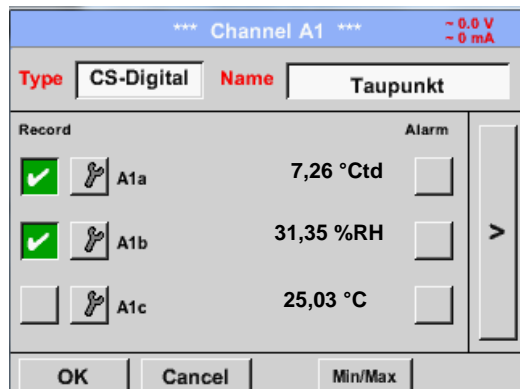

The DS 400 detects, if the connected sensor is a flow or dewpoint sensor of **CS Instruments** and set the **CS-Digital** subtype automatically correct.

Now, a **Name** (See chapter [12.2.2.7 Label and setting the description fields](#)), the **alarm settings** (See chapter [12.2.2.4 Alarm settings](#)) and **recording settings** (See chapter [12.2.2.3 Recording measurement data](#)), and the **Resolution** of the **decimal places** (See chapter [12.2.2 Name measurement data and define the decimal places](#)) can be determined.

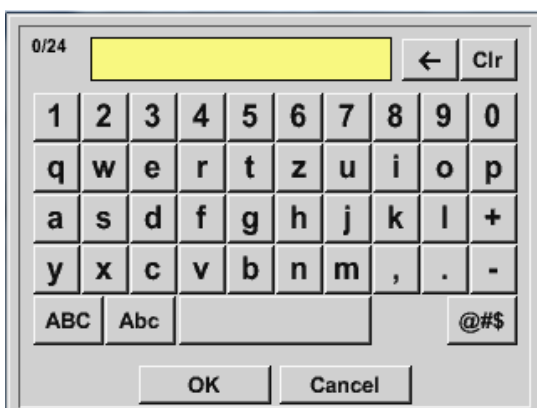

It is possible to enter a name with 24 characters.

Third step: confirm with **OK** two times

Sensor-Settings / Type CS -Digital

13.2.2.7 Flow sensor VA 400 / VA 420 of type CS-Digital (SDI Bus)

First step: choose an unused sensor channel

Main menu → Settings → Sensor settings → A1

Second step: choose type CS-Digital (inserted Digitalboard for A1/A2)

Main menu → Settings → Sensor settings → A1 → Type description field → CS-Digital

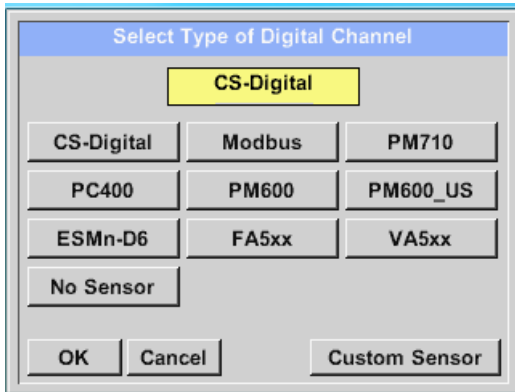

Now the *Type CS-Digital* is selected for the VA/FA 400 series and confirmed by pressing the *OK* button.

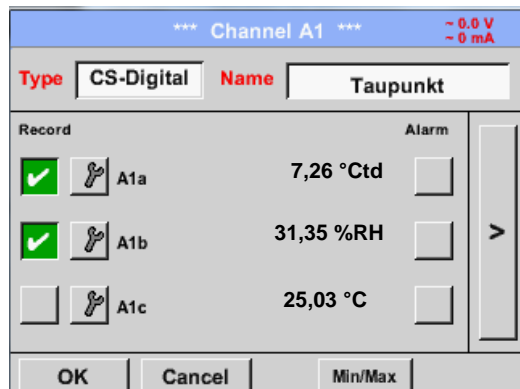

The DS 400 detects, if the connected sensor is a flow or dewpoint sensor of **CS Instruments** and set the *CS-Digital* subtype automatically correct.

Now, a *Name* (See chapter [12.2.2.7 Label and setting the description fields](#)), the **alarm settings** (See chapter [12.2.2.4 Alarm settings](#)) and **recording settings** (See chapter [12.2.2.3 Recording measurement data](#)), and the *Resolution* of the **decimal places** (See chapter [12.2.2.2 Name measurement data and define the decimal places](#)) can be determined.

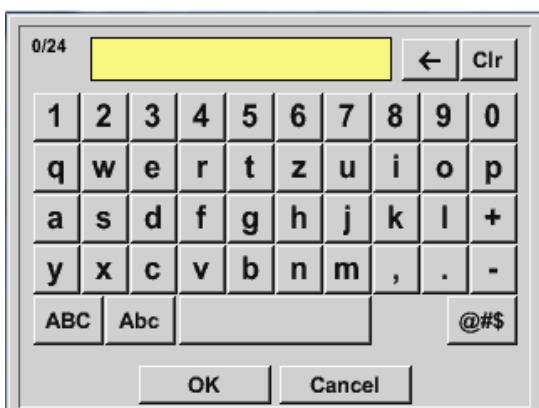

It is possible to enter a name with 24 characters.

Third step: confirm with **OK** two times

Main menu → Settings → Sensor settings → A1 → arrow right (2.page) → diameter description field

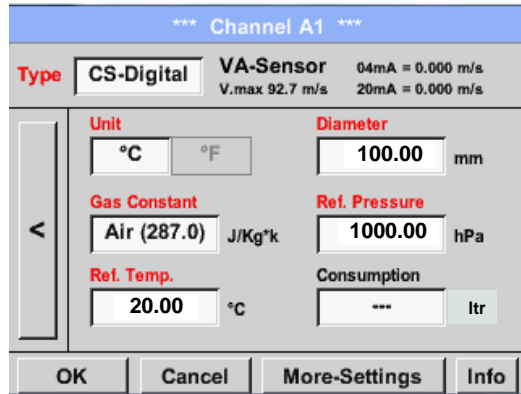
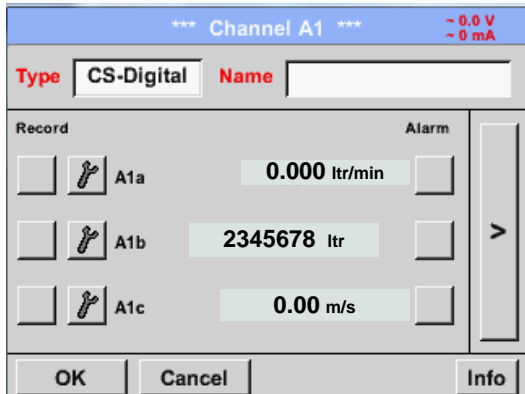

By entering the white text fields the value could be added or changed content could be change

Main menu → Settings → Sensor settings → A1 → arrow right (2.page) → diameter description field

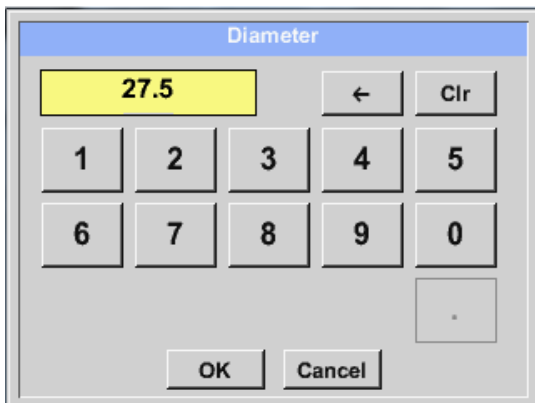

Important:

The **inner diameter** of flow tube can be entered here, if this was not automatically correctly set.

In

Please confirm by pressing the **OK** button and go back with **arrow left (1.page)**.

Important:

The **inner diameter** should be entered as precisely as possible, because otherwise the measurement results are not correct!

There is no uniform standard for the tube **inner diameter**!
(Please, inquire at the manufacturer or measure by your own !)

Sensor-Settings / Type FA 5xx

Main menu → Settings → Sensor settings → A1 → arrow right (2.page) → Gas Constant description field

Air-1		
Air (287.0)		
Air (287.0)	CO2 (188.9)	N2O (187.8)
N2 (296.8)	O2 (259.8)	NG (446.0)
Ar (208.0)	He	H2
C3H8	CH4	
OK Abbruch		

A preset selection of suitable *Gas Constants*.

Remark:

After confirm with **OK**, the font is black again and the values and settings are accepted.

Attention:

Reference temperature and reference pressure (factory setting 20 °C, 1000 hPa):
All volume flow values (m³/h) and consumption values indicated in the display are related to 20 °C, 1000 hPa (according to ISO 1217 intake condition)
0 °C and 1013 hPa (= standard cubic meter) can also be entered as a reference.
Do not enter the operation pressure or the operation temperature under reference conditions!

13.2.2.8 Dew Point Sensor FA 500 / FA 510 of type FA 5xx (RS 485 Modbus)

First step: choose an unused sensor digital channel

Main menu → Settings → Sensor settings → A1

Second step: choose type FA 5xx (inserted Digitalboard for A1/A2)

Main menu → Settings → Sensor settings → A1 → Type description field → FA 5xx

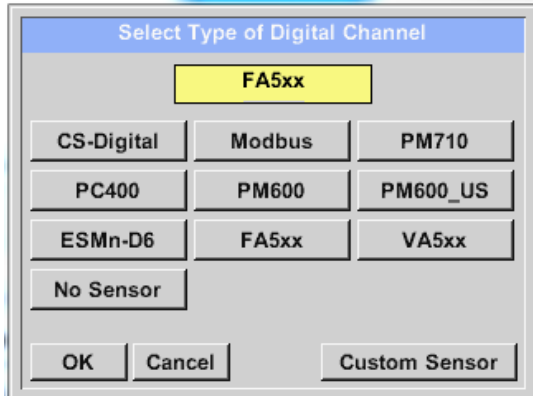

Now the *Type FA 5xx* is selected for the FA 5xx series and confirmed by pressing the *OK* button.

Now, a *Name* (See chapter [12.2.2.7 Label and setting the description fields](#)), the **alarm settings** (See chapter [12.2.2.4 Alarm settings](#)) and **recording settings** (See chapter [12.2.2.3 Recording measurement data](#)), and the **Resolution** of the decimal places (See chapter [12.2.2.2 Name measurement data and define the decimal places](#)) can be determined.

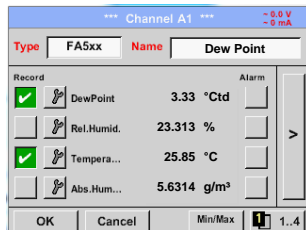

Input of a name, please enter the text field „*Name*“.

It is possible to enter a name with max. 24 characters.

Confirmation by pressing the *OK*-button.

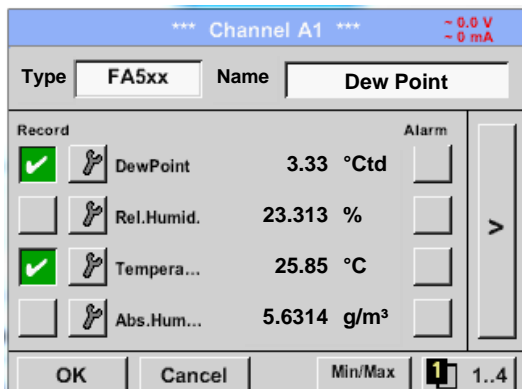
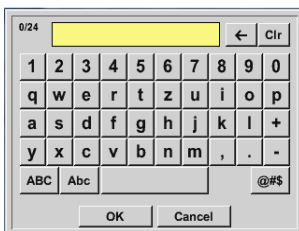

The connection with the FA 5xx sensor is done after confirmation by pressing “*OK*”.

Sensor-Settings / Type FA 5xx

13.2.2.8.1 Settings Dew point sensor FA 500 FA 510

13.2.2.8.2 Unit selection for temperature and humidity

Main menu → Settings → Sensor settings → A1 → arrow right (2.page)

Unit selection for temperature and humidity by pressing the button °C, °F, g/m³ or mg/m³.

Confirm the settings by pressing the OK button.

13.2.2.8.3 Definition of the System pressure (relative pressure value)

Actual there are 2 possibilities to define system pressure (input as relative pressure value)

- System pressure as a fixed value
- System pressure taken over from an external pressure sensor

Main menu → Settings → Sensor settings → A1 → arrow right (2.page) → Pressure Setting → Fixed

The definition of the fixed value system pressure value is done by activating the button "fixed", but this is only required in case a ext. pressure probe is connected.

The value is entered in the corresponding text field. The unit can be freely selected, selection menu is opened by pressing the corresponding button units

Confirm the settings by pressing the OK button.

Sensor-Settings / Type FA 5xx

Main menu → Settings → Sensor settings → A1 → arrow right (2.page) → Pressure Setting → Sensor

By using an ext. pressure sensor, which is detected automatically e.g. here at input B1, the button *Sensor* has to be activated.

With activation of the text field „Sys Pressure“ the corresponding channel with the required measuring value could be selected

Only values with pressure units can be selected.

Confirm the settings by pressing the *OK* button.

13.2.2.8.4 Definition of Reference pressure (absolute pressure value)

Main menu → Settings → Sensor settings → A1 → arrow right (2.page) → Pressure Setting → Textfield Ref.Pressure

Reference pressure is the pressure for that the dew point in relaxation will be back-calculated.

Default- Value is 1013 mbar (Atm. Pressure).

Confirm the settings by pressing the *OK* button.

13.2.2.8.5 Calibration

Main menu → Settings → Sensor settings → A1 → arrow right (2.page) → Calibration

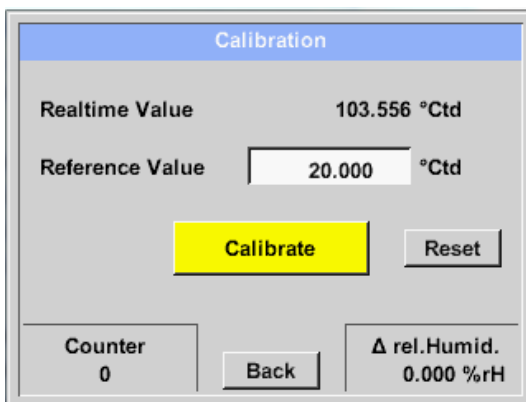
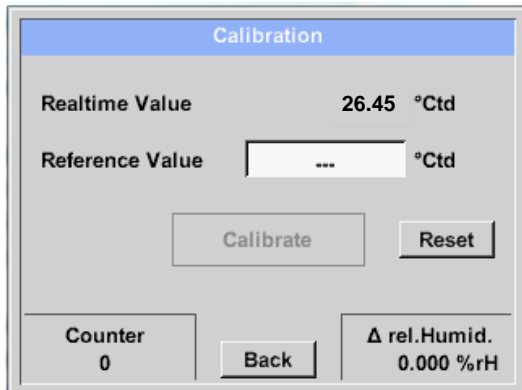

Here, a one-point calibration can be performed.

For that purpose, please enter in the text box "Reference Value" the new correct dew point value.

Then by pressing the "Calibration" button taking over the inserted reference value.

Calibration can be put back to factory setting by pressing „Reset“.

For each performed calibration, the counter is increased by 1.

13.2.2.8.6 More Settings Analogue output 4-20mA

Main menu → Settings → Sensor settings → A1 → arrow right (2.page) → More-Settings → 4-20mA

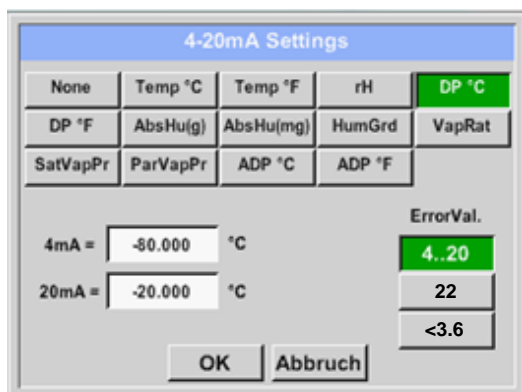

This menu allows the adjustment / assignment of the measurement value and the scaling of the analogue output.

Selection of the measurement value by selecting the appropriate measured value key in this example, "DP ° C" for dew point ° Ctd.

In text fields "4mA" and "20mA" the appropriate scaling values are entered, here from -80 ° Ctd (4mA) to -20 ° Ctd (20mA).

With "Error Val" is determined what is output in case of error at the analog output.

- <3.6 Sensor error / System error
- 22 Sensor error / System error
- 4..20 Output according Namur (3.8mA – 20.5 mA)
< 4mA to 3.8 mA Measuring range under range
>20mA to 20.5 mA Measuring range exceeding

Sensor - Settings / Type VA 5xx

13.2.2.9 Flow sensor of type VA 5xx (RS 485 Modbus)

First step: choose an unused sensor digital channel

Main menu → Settings → Sensor settings → A1

Second step: choose type VA 5xx (inserted Digitalboard for A1/A2)

Main menu → Settings → Sensor settings → A1 → Type description field → VA 5xx

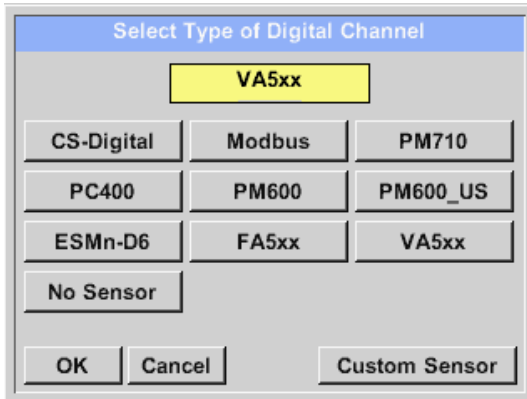

Now the **Type VA 5xx** is selected for the VA 5xx series and confirmed by pressing the **OK** button.

Now, a **Name** (See chapter [12.2.2.7 Label and setting the description fields](#)), the **alarm settings** (See chapter [12.2.2.4 Alarm settings](#)) and **recording settings** (See chapter [12.2.2.3 Recording measurement data](#)), and the **Resolution of the decimal places** (See chapter [12.2.2.2 Name measurement data and define the decimal places](#)) can be determined.



Input of a name, please enter the text field „**Name**“.

It is possible to enter a name with max. 24 characters.

Confirmation by pressing the **OK**-button.

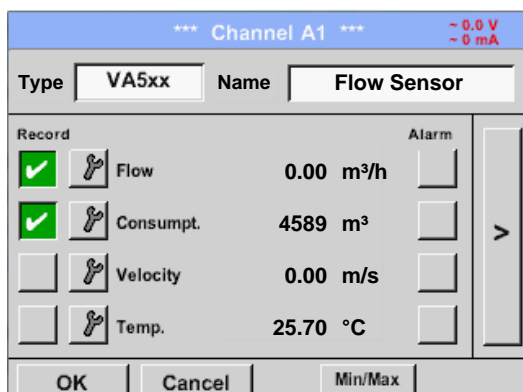

The connection with the VA 5xx sensor is done after confirmation by pressing **“OK”**.

Sensor - Settings / VA 5xx

13.2.2.9.1 Settings for Flow sensor VA 5xx

Main menu → Settings → Sensor settings → A1 → arrow right (2.page)

Type		VA-Sensor	
Flow	Velocity	Diameter	Unit
m ³ /h	m/s	53.100	mm
Gas Constant	Ref. Pressure	Unit	
Air (real) J/Kg*k	1000.00	mbar	
Ref. Temp.	Unit	Count.Val	Unit
20.000	°C	4589	m ³

OK Cancel More-Settings Info

For each text field could be the either a value or a unit be set.

Settings by entering the text field and then input a value or select the unit for the appropriate field.

In case of VA 520 and VA 570 with integrated measuring section the diameter and diameter unit field are not access able.

13.2.2.9.1.1 Diameter settings

Main menu → Settings → Sensor settings → A1 → arrow right (2.page) → diameter description field

Diameter

27.5

← Clr

1 2 3 4 5

6 7 8 9 0

.

OK Cancel

Important:

The **inner diameter** of flow tube can be entered here, if this was not automatically correctly set.

In

Please confirm by pressing the **OK** button and go back with **arrow left (1.page)**.

Important:

The **inner diameter** should be entered as precisely as possible, because otherwise the measurement results are not correct!

There is no uniform standard for the tube **inner diameter**!
(Please, inquire at the manufacturer or measure by your own !)

Sensor - Settings / VA 5xx

13.2.2.9.1.2 Gas Constant settings

Main menu → Settings → Sensor settings → A1 → arrow right (2.page) → Gas Constant description field

Air (real)		
Air (real)	CO2 (real)	H2 (real)
NO2 (real)	CO2 (188.9)	N2O (187.8)
N2 (296.8)	O2 (259.8)	NG (446.0)
Ar (208.0)		

OK Cancel

All gases marked in blue and with (real) have been a real gas calibration curve stored in the sensor.

Select the gas you require and confirm selection by pressing **OK** button.

Attention:

Reference temperature and reference pressure (factory setting 20 °C, 1000 hPa):
All volume flow values (m³/h) and consumption values indicated in the display are related to 20 °C, 1000 hPa (according to ISO 1217 intake condition)
0 °C and 1013 hPa (= standard cubic meter) can also be entered as a reference.
Do not enter the operation pressure or the operation temperature under reference conditions!

Sensor - Settings / VA 5xx

13.2.2.9.1.3 Definition of the reference conditions

Here, the desired measured media reference conditions for pressure and temperature can be defined

Main menu → Settings → Sensor settings → A1 → arrow right (2.page) → Ref. Pressure description field

Main menu → Settings → Sensor settings → A1 → arrow right (2.page) → Ref. Pressure Unit description field

The left screenshot shows the 'Ref. Pressure' input screen. It features a numeric keypad with digits 1-9, 0, and a decimal point. The value '1000' is displayed in a yellow box. Navigation buttons include a left arrow, 'Clr', 'OK', and 'Cancel'.

The right screenshot shows the 'Ref. Pressure Unit' selection screen. A yellow box displays 'mbar'. Below it is a grid of unit options: mbar, psi, hpa, and several empty boxes. 'OK' and 'Cancel' buttons are at the bottom.

Main menu → Settings → Sensor settings → A1 → arrow right (2.page) → Ref. Temp. description Field

Main menu → Settings → Sensor settings → A1 → arrow right (2.page) → Ref. Temp. Unit description Field

The left screenshot shows the 'Ref. Temp.' input screen. It features a numeric keypad with digits 1-9, 0, and a decimal point. The value '20' is displayed in a yellow box. Navigation buttons include a left arrow, 'Clr', 'OK', and 'Cancel'.

The right screenshot shows the 'Ref. Temp. Unit' selection screen. A yellow box displays '°C'. Below it is a grid of unit options: °C, °F, and several empty boxes. 'OK' and 'Cancel' buttons are at the bottom.

13.2.2.9.1.4 Definition Unit of flow and velocity

Main menu → Settings → Sensor settings → A1 → arrow right (2.page) → Flow description Field

Main menu → Settings → Sensor settings → A1 → arrow right (2.page) → Velocity description Field

The left screenshot shows the 'Flow Unit' selection screen. A yellow box displays 'm³/h'. Below it is a grid of flow units: m³/h, Nm³/h, m³/min, Nm³/min, ltr/h, Nltr/h, ltr/min, NI/min, ltr/s, NI/s, cfm, SCFM, kg/h, kg/min, kg/s, and kW. 'OK' and 'Cancel' buttons are at the bottom.

The right screenshot shows the 'Velocity Unit' selection screen. A yellow box displays 'm/s'. Below it is a grid of velocity units: m/s, Nm/s, fpm, SFPM, and several empty boxes. 'OK' and 'Cancel' buttons are at the bottom.

Sensor - Settings / VA 5xx

13.2.2.9.1.5 Definition consumption counter value and consumption unit

Main menu → Settings → Sensor settings → A1 → arrow right (2.page) → Count Val. description Field

Main menu → Settings → Sensor settings → A1 → arrow right (2.page) → Count Val. Unit description Field

The sensor allows taking over a starting counter value. Inserting the value by entering the "Count. Val." text field.

In the Count. Val. Unit field different units could be used. Selection by activation of the "Count. Val. Unit" text field

In case the counter value unit will be changed only the consumption counter value will be recalculated to the appropriate unit.

Selection to confirm selection by pressing **OK** button.

Important!
When the counter reach 10000000 m³ the counter will be reset to zero.

Remark:

After confirmation with **OK**, the font is black again and the values and settings are accepted

13.2.2.9.2 Settings analogue output 4-20mA of VA 5xx

Main menu → Settings → Sensor settings → A1 → More-Settings → 4-20mA Ch1

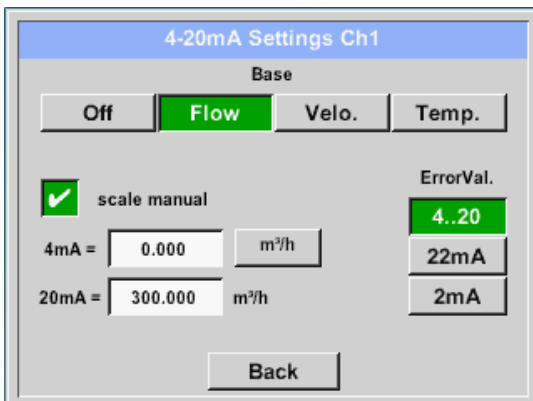
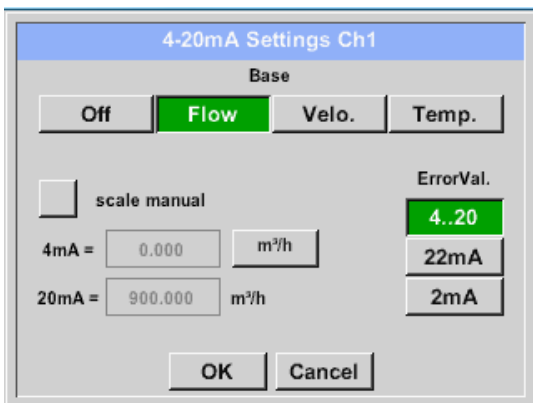
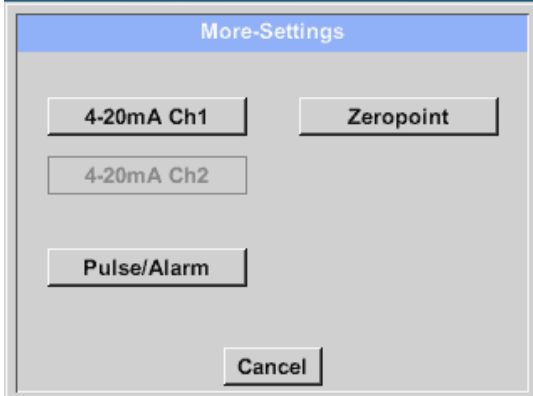

This menu allows the adjustment / assignment of the measurement value and the scaling of the analogue output by pressing the "4-20mA Ch1" button.

Selection of the analogue output measurement value by activating the appropriate measured value key in this example, "Flow".

Possible outputs are flow, velocity and temperature. In case of no use, please select "Off".

The analogue output scaling have to possibilities, automatic scaling (default) and a manual scaling by the user. Auto scaling is based on the calibration settings, means 4mA is set to zero and the 20mA value is based on the max. settings here 900m³/h

A "manual scaling" needs an activation of the "scale manual" button.

In text fields "4mA" and "20mA" the appropriate scaling values are entered, here from zero m³/h (4mA) to 300 m³/h (20mA).

With "Error Val" it is determined what is the output in case of an error at the analogue output.

- 2 mA Sensor error / System error
- 22 mA Sensor error / System error
- 4..20 Output according Namur (3.8mA – 20.5 mA)
< 4mA to 3.8 mA Measuring range under range
>20mA to 20.5 mA Measuring range exceeding

Inputs / changes to be confirmed with "OK" button. Return to main menu with "Back".

Sensor - Settings / VA 5xx

13.2.2.9.3 Settings Pulse / Alarm output of VA 5xx

Main menu → Settings → Sensor settings → A1 → More-Settings → Pulse / Alarm

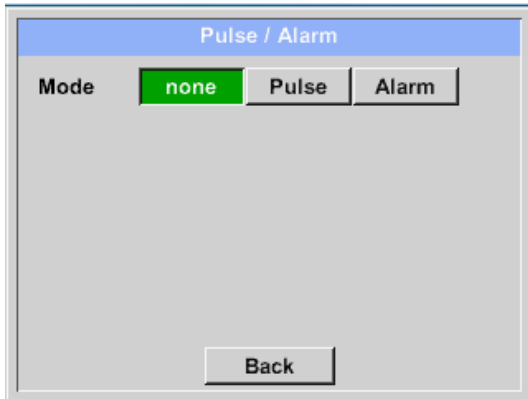

The pulse output of the VA 5xx could be set functionally as pulse output or alarm output.

Function to activate by pressing either the "Pulse" or "Alarm" button.

In case of no use, please select "none".

Inputs / changes to be confirmed with "OK" button. Return to main menu with "Back".

Main menu → Settings → Sensor settings → A1 → More-Settings → Pulse

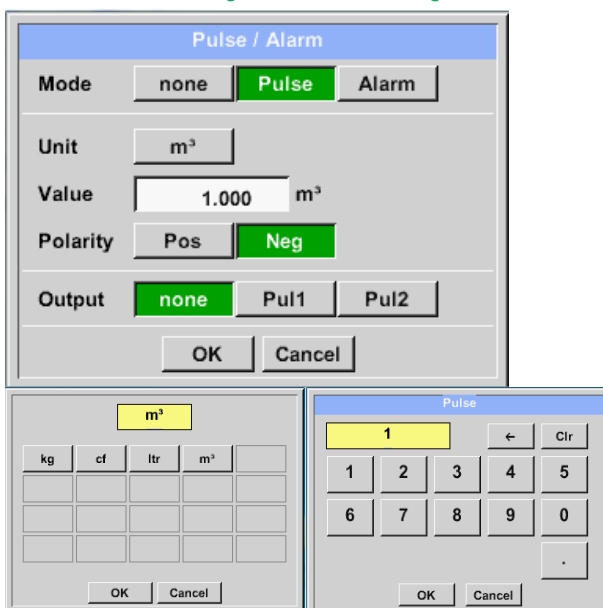

To set up the pulse first the unit and the measurement value have to be defined.

Unit selection by pressing "unit" button and choice one of the possible units "kg", "cf", "ltr" or "m³".

Pulse weight setting by entering the text field "Value".

Here with defined 1 pulse per m³ and with positive polarity.

With „Polarity“ the switching state could be defined.

Pos. = 0 → 1 neg. 1 → 0

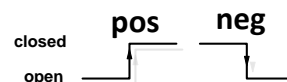

Inputs / changes to be confirmed with "OK" button. Return to main menu with "Back".

Furthermore, the DS400 also offers the option to provide the pulses, galvanically isolated, directly, this requires the option boards "Pulse" or "Ethernet"

The output of the pulses can alternatively be made at plug "D" on pulse 1 or pulse 2. However, the pulse outputs can only be assigned once.

Main menu → Settings → Sensor settings → A1 → More-Settings → Pulse → output → Imp1 or. Imp 2

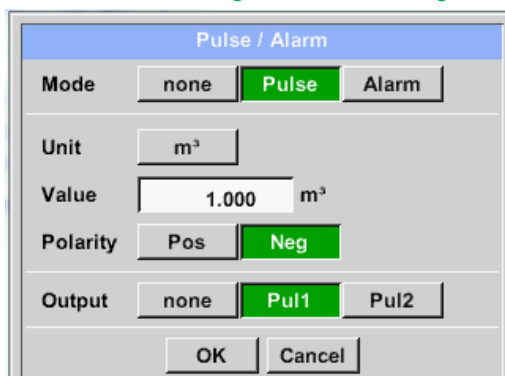

Select the impulse output using the "Imp1" or "Imp2" key.

In case of no use of a galvanically isolated pulse output, please select "none".

Inputs / changes to be confirmed with "OK" button. Return to main menu with "Back".

Sensor - Settings / VA 5xx

Main menu → Settings → Sensor settings → A1 → More-Settings → Alarm

Pulse / Alarm

Mode: none Pulse **Alarm**

Unit: °C

Value: 55.000 +/- 2.000 °C

Limit: **High** Low

OK Cancel

°C

cfm	ltr/s	m ³ /h	m/s	°F
°C	kg/s	kg/min		

OK Cancel

Alarm

55 ← Ctr

1	2	3	4	5
6	7	8	9	0
-			.	

OK Cancel

In case of use the pulse output as alarm following definitions needs to be set:

Unit selection by pressing “unit” button and choice one of the possible units “cfm”, “ltr/s”, “m³/h”, “m/s”, “°F”, “°C”, “kg/s” or “kg/min”).

Alarm value setting by entering the text fields “Value”.

The limits „High“ or „Low“ defines when the alarm is activated, selecting by pressing the appropriate button

High: Value over limit

Low: Value under limit

Inputs / changes to be confirmed with “OK” button. Return to main menu with “Back”.

Sensor - Settings / VA 5xx

13.2.2.9.4 Settings ZeroPoint or Low Flow Cut off for VA 5xx

Main menu → Settings → Sensor settings → A1 → More-Settings → Zeropoint

The screenshot shows the 'Zero Setup' screen. At the top, it says 'Zero Setup'. Below that, 'Actual Flow' is displayed as 2.045. There are two input fields: 'ZeroPoint' and 'CutOff', both containing '---'. At the bottom left is a 'Reset' button, and at the bottom center is a 'Back' button.

The screenshot shows the 'Zero Setup' screen. 'Actual Flow' is 200.732. The 'ZeroPoint' field now contains the value 2.045. The 'CutOff' field still contains '---'. At the bottom left is a 'Reset' button, and at the bottom center are 'OK' and 'Cancel' buttons.

The screenshot shows the 'Zero Setup' screen. 'Actual Flow' is 2.045. The 'ZeroPoint' field contains '---'. The 'CutOff' field now contains the value 10.000. At the bottom left is a 'Reset' button, and at the bottom center are 'OK' and 'Cancel' buttons.

With these function following adjustments for the sensor VA 5xx could be done:

Zeropoint:

When, without flow, the installed sensor shows already a flow value of $> 0 \text{ m}^3/\text{h}$ herewith the zero point of the characteristic could be reset

Cutoff:

With the low-flow cut off activated, the flow below the defined "LowFlow Cut off" value will be displayed as $0 \text{ m}^3/\text{h}$ and not added to the consumption counter.

For Zero Point the text field "ZeroPoint" to enter and insert the displayed actual flow, here 2.045

For inserting low flow cutoff value activate the text field "CutOff" and insert the required value, here 10.

With the "Reset" button all entries could be set back to zero.

Inputs / changes to be confirmed with "OK" button. Return to main menu with "Back".

Sensor-settings / Configuration of Analogue-Sensors

13.2.2.10 Configuration of Analog-Sensors

Applicable only at DS 400 variants with an analog board equipped.

A brief overview of the possible *Type* of settings with examples.

Except *CS-Digital*, see chapter [12.2.2.1 Choice of the sensor types \(For example type CS-Digital sensor\)](#) and [12.2.2.6 Dewpoint sensor with type CS-Digital](#).

The **Alarm** (See chapter [12.2.2.4 Alarm settings](#)) and **Record** buttons (See chapter [12.2.2.3 Recording measurement data](#)), the **Resolution of the decimal places** and **Short Name** or **Value Name** (See chapter [12.2.2.2 Name measurement data and define the decimal places](#)), and the **More-Settings** (See chapter [12.2.2.5 More-Settings \(scale analogue output\)](#)) are all described in chapter [12.2.2 Sensor settings](#).

The caption of description fields, see chapter [12.2.2.7 Label and setting the description fields](#).

13.2.2.10.1 Type 0 - 1/10/30 Volt und 0/4 – 20 mA

Main menu → Settings → Sensor settings → B1 → Type description field → 0 - 1/10/30 V

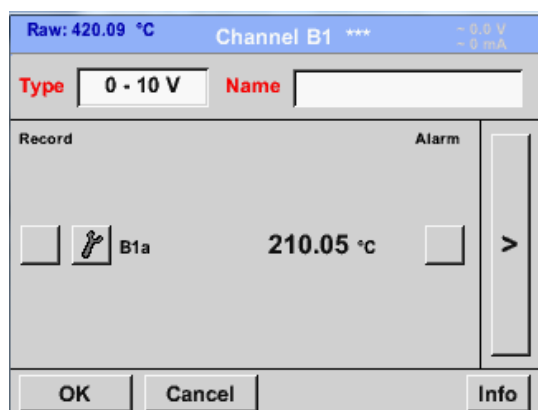

Please see the scale of the sensor (here for example *Type 0 - 10V* corresponds to 0 - 250 ° C) from the data sheet of the connected sensor.

By *Scale 0V* enter the lower and by *Scale10V* the upper scale value.

Main menu → Settings → Sensor settings → B1 → arrow right (2.page)

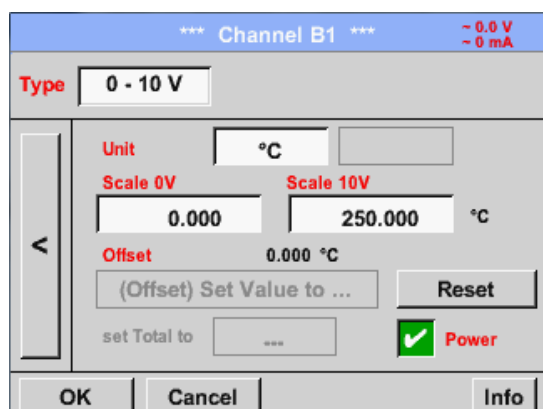

By *Scale 0V* enter the lower and by *Scale10V* the upper scale value

The *Sensor Supply Voltage* is switched **On**, if it's required by the sensor type, otherwise off (no green hook).

Please confirm by pressing the **OK** button.

Sensor-settings / Configuration of Analogue-Sensors

It is possible to define an Offset-Value. With the *Set Value to*-button (*Offset*) you enter it. The positive or negative difference of the *Offset* will be displayed.

By pressing the *Reset*-button the *Offset* will be deleted.

Main menu → Settings → Sensor settings → B1 → arrow right (2.page) → description field Unit

A preset selection of suitable units by *Type* 0 - 1/10/30 V and 0/4...20 mA.

The different pages could be displayed by pressing the *Page*-button.

In addition, *User* specific units could be defined

Here with the *Edit* button could analog to *description field* a *User* unit be defined.

Main menu → Settings → Sensor settings → A1 → Type description field → 0/4 - 20 mA

Here for example *Type 4 - 20 mA*.

13.2.2.10.2 Type PT100x and KTY81

Main menu → Settings → Sensor settings → B1 → Type description field → PT100x

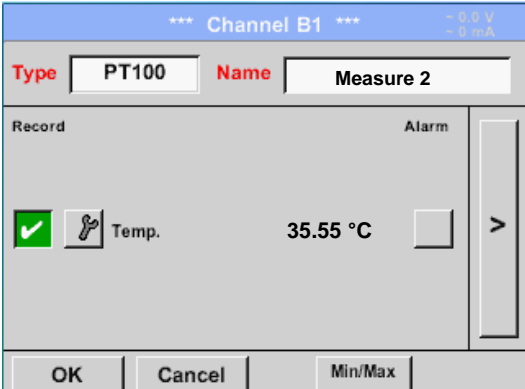

Here the sensor type *PT100* and the *Unit* in °C are chosen, alternatively the sensor types *PT1000* and *KTY81*, as well as the *Unit* °F can be selected.

More setting options, see chapter [12.2.2.8.1 Type 0 - 1/10/30 Volt and 0/4 - 20 mA](#)

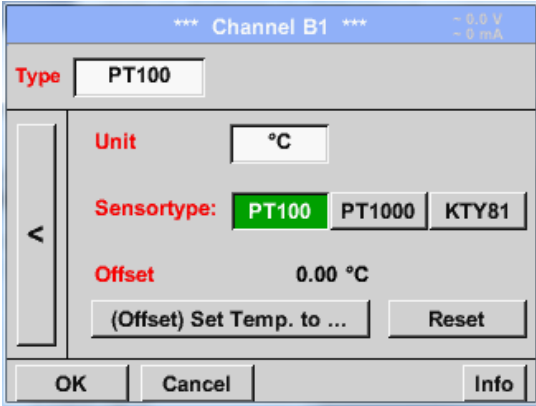

Sensor-settings / Configuration of Analogue-Sensors

13.2.2.10.3 Type Pulse (Pulse ration)

Main menu → Settings → Sensor settings → B1 → Type description field → Type description field → Pulse

*** Channel B1 ***
- 0.0 V
- 0 mA

Type **Pulse** Name **Measure 3**

Record	Alarm
<input checked="" type="checkbox"/> B1a 9000 m ³ /h	<input type="checkbox"/>
<input checked="" type="checkbox"/> B1b 367001 m ³	<input type="checkbox"/>
<input type="checkbox"/> B1c 50 Hz	<input type="checkbox"/>

OK Cancel Info

Typically the value with unit of **1 Pulse** is standing on the sensor and can directly entered to the **1 Pulse =** description field.

Remark:

Here, all description fields are already labeled or occupied.

*** Channel B1 ***
- 0.0 V
- 0 mA

Type **Pulse**

1 Pulse = m³

Unit	Pulse	Consumption	Counter
<input type="text" value="m<sup>3</sup>"/>	<input type="text" value="m<sup>3</sup>"/>	<input type="text" value="m<sup>3</sup>/h"/>	<input type="text" value="m<sup>3</sup>"/>

Counter m³ Power

OK Cancel Info

Main menu → Settings → Sensor settings → B1 → arrow right (2.page) → Unit Pulses

m³

	ltr	m ³	Nltr	Nm ³
cf	Ncf	kg	kWh	PCS

OK Cancel

By *Unit Pulse* you can choose between a flow volume or a power consumption unit.

Sensor-settings / Configuration of Analogue-Sensors

Main menu → Settings → Sensor settings → B1 → arrow right (2.page) → Unit Consumption

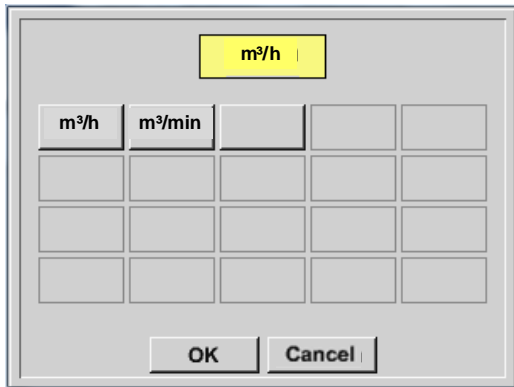

Unit of current *Consumption* by *Type Pulse*

Remark:

Example with the unit cubic meters / hour.

Main menu → Settings → Sensor settings → B1 → arrow right (2.page) → Unit Counter

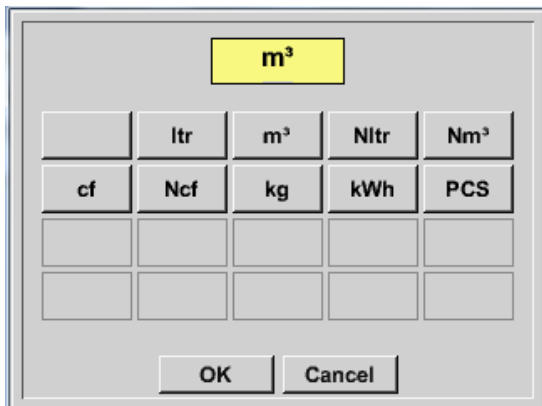

The available Units for the *Unit of Counter* by *Type Pulse*

The **counter** can be set any time to any value you need.

More setting options, see chapter [12.2.2.8.1 Type 0 - 1/10/30 Volt and 0/4 - 20 mA!](#)

Sensor-settings / Type „No Sensor“

13.2.2.10.4 Type „No Sensor“

Main menu → Settings → Sensor settings → A2 → Type description field → No Sensor

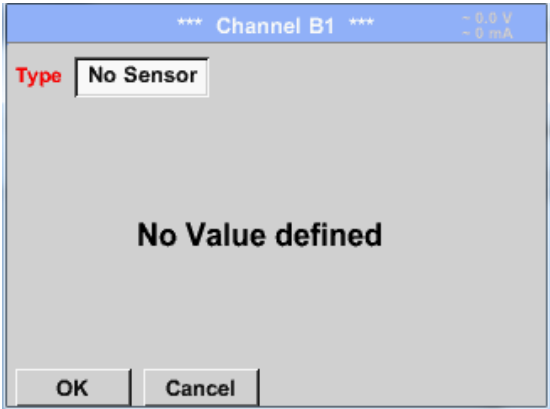

Is used to declare a not currently needed channel as *No Sensor defined*.

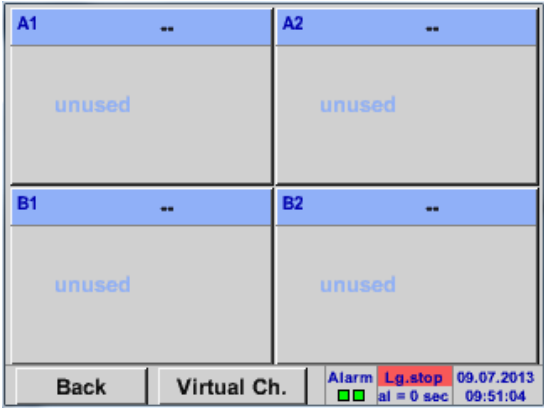

If you go to *Type No Sensor Back*, channels will appear as *unused*.

Sensor-settings / Type „Modbus“

13.2.2.11 Type Modbus

13.2.2.11.1 Selection and activation of Sensor-Type Modbus

First Step: First step: choose an unused sensor channel

Main menu → Settings → Sensor settings → A1

Second step: choose type Modbus

Main menu → Settings → Sensor settings → A1 → Type description field → Modbus

Third step: confirm with **OK**.

Now, a **Name** (See chapter [12.2.2.7 Label and setting the description fields](#)),) can be determined.

Main menu → Settings → Sensor settings → A1 → arrow right (2.page) → Va → use

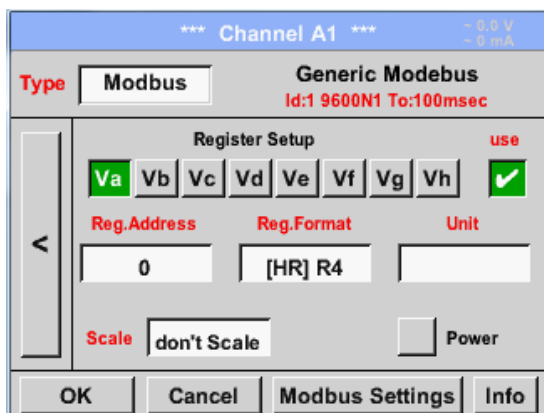

Via Modbus it is possible to read out up to 8 Register-Values (from Input or Holding Register) of the sensor.

Selection by the Register Tabs *Va – Vh* and activation by pressing of the corresponding *Use* button.

13.2.2.11.2 Modbus Settings

Main menu → Settings → Sensor settings → A1 → arrow right (2.page) → Modbus Settings → ID - Textfield

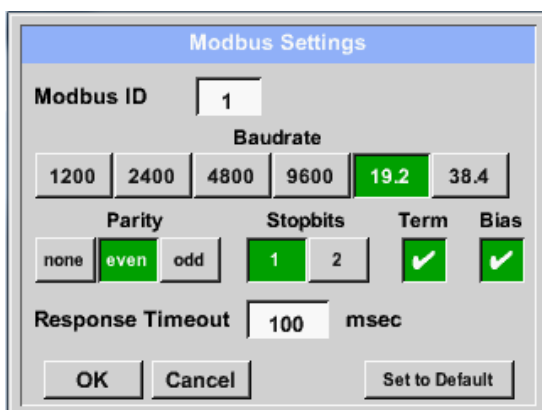

Please insert here the specified *Modbus ID* of the sensor, allowed values are 1 -247, (e.g.. here *Modbus ID = 22*)

For setting the Modbus ID on the sensor please see sensor-datasheet.

In addition in the menu are the serial transmission settings *Baudrate*, *Stopbit*, *Paritybit* and *Timeout* time to define.

In case that the DS400 is the end of the RS485 bussystem with activating *Term-* & *Bias-* button the required termination and biasing could be activated.

Confirmation by pressing **OK** button.

For resetting to the default values please press *Set to Default*.

Sensor-settings / Type “Modbus”

Main menu → Settings → Sensor settings → A1 → Reg. Address description field

The measurement values are kept in the registers of the sensor and can be addressed via Modbus and read by the DS400.

This requires setting the desired register addresses in the DS400.

Entering the register / data address is here in decimal with 0-65535.

Important:

Required is the correct *register-address*.

It should be noted that the register-number could be different to the register-address (Offset). For this please consult the sensor data sheet.

Main menu → Settings → Sensor settings → A1 → Reg. Format description field

With the buttons *Input Register* and *Holding Register* the corresponding Modbus-register type will be selected.

The number format and transmission order of each value needs to be defined by *Data Type* and *Byte Order*. Both have to be applied in correct combination.

Supported Data types:

Data Type:	UI1 (8b) = unsigned Integer	=>	0	-	255
	I1 (8b) = signed integer	=>	-128	-	127
	UI2 (16b) = unsigned Integer	=>	0	-	65535
	I2 (16b) = signed integer	=>	-32768	-	32767
	UI4 (32b) = unsigned Integer	=>	0	-	4294967295
	I4 (32b) = signed integer	=>	-2147483648	-	2147483647
	R4 (32b) = floating point number				

Byte Order:

The size of each Modbus-register is 2 Byte. For a 32 bit value two Modbusregister will be read out by the DS400. Accordingly for a 16bit Value only one register is read.

In the Modbus Specification the sequence of the transmitted bytes is not defined clearly. To cover all possible cases, the byte sequence in the DS400 is adjustable and must adapted to the respective sensor. Please consult here for the sensor datasheet.

e.g.: High byte before Low Byte, High Word before Low Word etc

Therefore the settings have to be made in accordance to the sensor data sheet.

Sensor-settings / Type "Modbus"

Beispiele :

Holding Register - UI1(8b) - Zahlenwert: 18

Selection Register Type *Holding Register*,
Data Type *UI1(8b)* und Byte Order *A / B*

	HByte	LByte
18 =>	00	12
Data Order	1. Byte	2. Byte
A	00	12
B	12	00

Holding Register – UI4(32) - Value: 29235175522 → AE41 5652

Selection Register Type *Holding Register*,
Data Type *UI1(32b)* und Byte Order *A-B-C-D*

	HWord		LWord	
	HByte	LByte	HByte	LByte
29235175522 =>	AE	41	56	52
Data Order	1.Byte	2.Byte	3.byte	4.Byte
A-B-C-D	AE	41	56	52
D-C-B-A	52	56	41	AE
B-A-D-C	41	AE	52	56
C-D-A-B	56	52	AE	41

Main menu → Settings → Sensor settings → A1 → Unit- description field

By pressing the description field *Unit*
the list with the available units appear

Please select the unit by pressing the
respective button e.g. *m³/h*.
For validation of the unit please push the
button *OK*
To move through the list please press the
button *Page*.
In case the unit is **not** available it is possible to
create a user defined unit.
Therefore, please select one of the *User_X*
buttons.

Sensor-settings / Type "Modbus"

Main menu → Settings → Sensor settings → A1 → Scale- description field

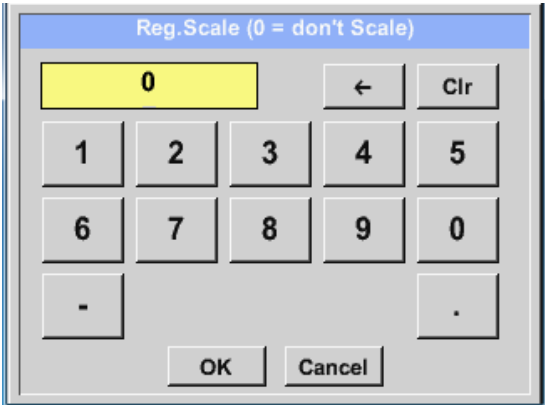

The use of this factor allows adapting the output value by the same.
By default or value = 0 no scaling is applied and displayed in the field is *don't scale*

Main menu → Settings → Sensor settings → A1 → OK

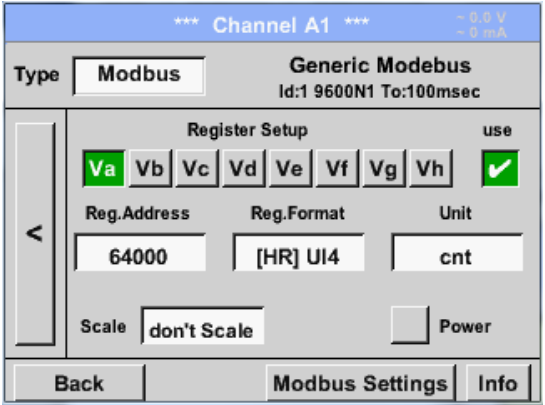

By pressing the *OK* button the inputs are confirmed and stored.

Custom Sensor

13.2.2.12 Custom Sensor

With regular use of different sensors or sensor settings it is possible, based on a basic sensors a so called predefined sensors-settings (Custom Sensor) to save and to read it back. Stored are all settings of the sensor except recording button and alarm settings..

Attention !

When applying the settings on different channels then the sensor name, value name and short name are inserted multiple times. Unfortunately, this must be checked and changed manually.

Main menu → Settings → Sensor Settings

Settings for the Base Sensor should be done accordingly chapter 12.2.2.2 to 12.2.2.10

13.2.2.12.1 Sensor settings saving

Main menu → Settings → Sensor Settings → Store

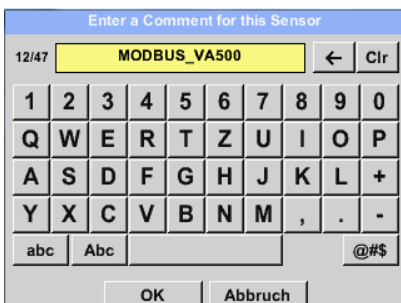
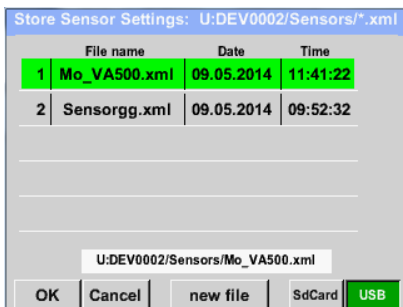
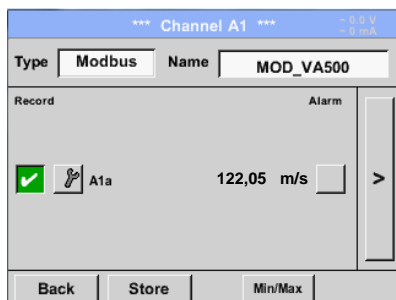

All already saved sensor settings will be displayed, depending on the location **USB** or **SdCard** selected.

Changing of the location by pressing button **USB** or **SdCard**

Location/path is: DEV0002/Sensors

By choosing one of the listed files their content will be overwritten by keeping the filename.

By choosing button **new file** a menu for inserting/defining the filename appears. The file name length is limited **to 8 chars**.

Confirm with **OK**

In addition to each file a comment/description could be added.

After confirming with **OK** the file is stored on the selected location.

Custom Sensor

13.2.2.12.2 Sensor settings import

Main menu → Settings → Sensor Settings → A1 → Type Textfield → Custom Sensor

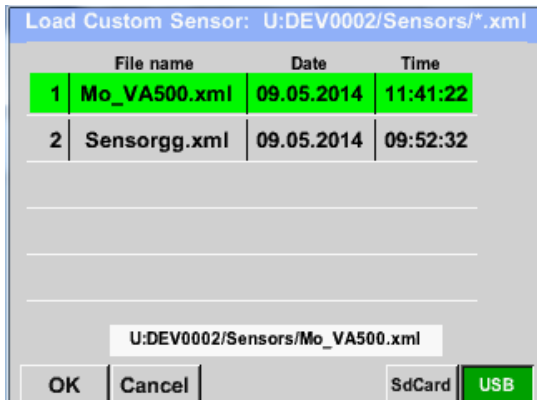

All already saved sensor settings will be displayed, depending on the location **USB** or **SdCard** selected.

Changing of the location by pressing button **USB** or **SdCard**

Then select the required sensor-setting file and confirm it with **OK**.

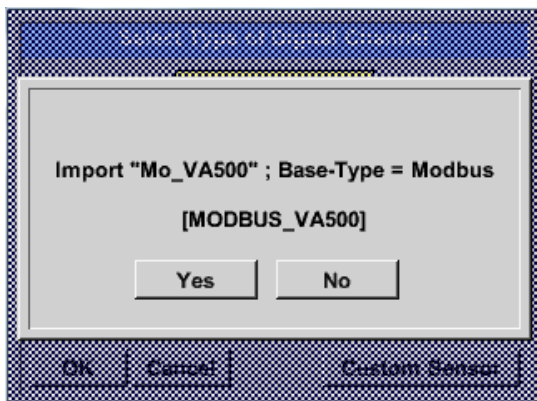

For a short verification the basetyp of sensor and also the comment stored is displayed

By pressing **OK** the data (settings) are imported.

If necessary the naming, recording- and alarm-settings needs to be adapted.

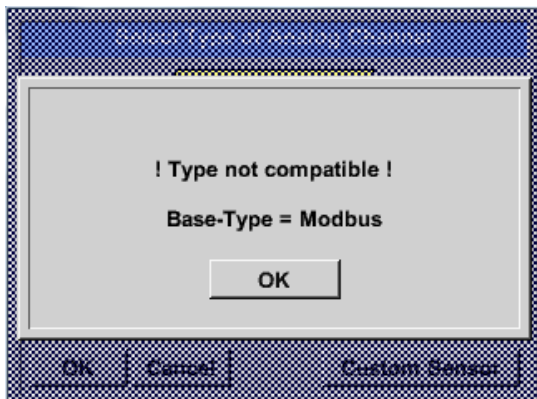

In case a wrong (not compatible) Sensor type (analogue / digital) has selected an error message will be displayed.

13.2.3 Device Settings

Main menu → Settings → Device settings

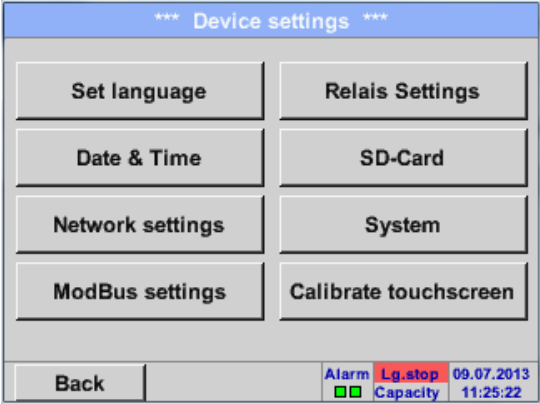

Overview of *Device settings*

13.2.3.1 Language

Main menu → Settings → Device settings → Set language

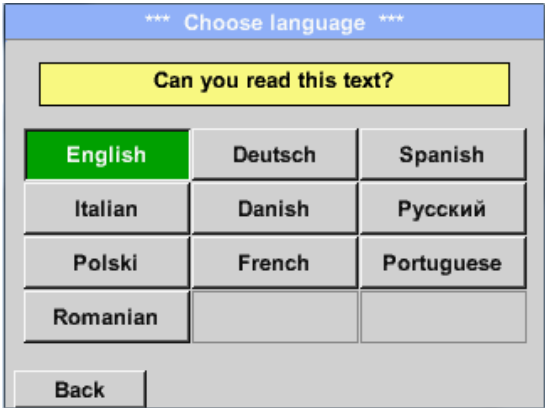

Here you can select one of 10 languages for the DS 400.

Device-Settings / Date & Time

13.2.3.2 Date & Time

Main menu → Settings → Device settings → Date & Time

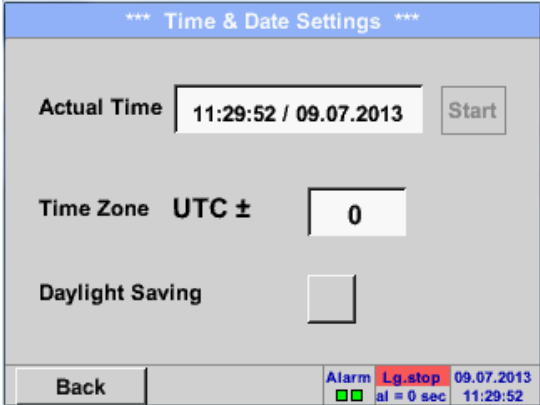

By pushing the *Time Zone* description field and enter the correct *UTC*, you can set the correct time all over the world.

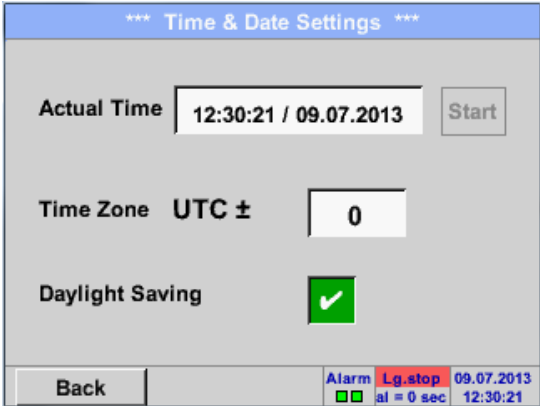

The summer and wintertime switchover is realized by pushing the *Daylight Saving* button.

Device-Settings / Network-Settings

13.2.3.3 Network-Settings

Main menu → Settings → Device settings → Network-Settings

*** Network settings ***

IP address via DHCP

IP address	Subnet Mask
192.172.168.44	255.255.255.0
Gateway address	DNS address
192.172.168.1	0.0.0.0
Host name	HTTP Port
D4-0789	80
WebAdmin Password	12345678

Back Apply & Restart

Here you can set up and made a connection, with or without *DHCP*, to a computer.

Remark:

With activated *DHCP* (green hook), the automatic integration of the DS 400 in an existing network is possible, without a manual configuration.

192 . 168 . 0 . 0

1	2	3	4	5
6	7	8	9	0

OK Cancel

After pushing, for example the *IP address* description field, the command window appears, where in the selected yellow area a partial *IP address* can be entered manually.

The *Host name* can be entered or changed by pushing the description field.

Subnet Mask and Gateway address are entered in the same way!

Label *Host name*, see chapter [12.2.2.7 Label and setting the description fields!](#)

*** Network settings ***

IP address via DHCP

IP address	Subnet Mask
192.172.168.44	255.255.255.0
Gateway address	DNS address
192.172.168.1	0.0.0.0
Host name	HTTP Port
D4-0787	80
WebAdmin Password	12345678

Back Apply & Restart

For example a *IP-Address* out of address range of the class C-Net

Remark:

Private Address range Class A-Net
10.0.0.0 to 10.255.255.255

Private Address range Class B-Net
72.16.0.0 to 172.31.255.255

Private Address range Class C-Net
192.168.0.0 to 192.168.255.255

Subnet Mask: e. g. 255.255.255.0

For the definition of the WebAdminPassword see Chapter 12.2.10 Webserver.

Device-Settings / Modbus (Slave)

13.2.3.4 ModBus (Slave)

With the *RS485 ModBus* interface customer specific systems (GLT, SPS, Scada) could be connected to the DS 400.

Main menu → Settings → Device settings → ModBus settings

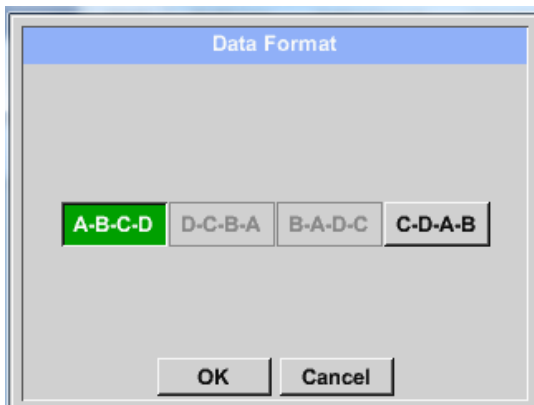
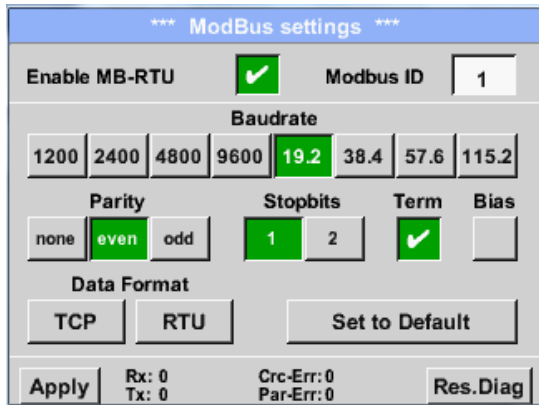

In this menu the transmission parameter *Modbus ID, Baudrate, Stoppbit und Parity* will be set. With activation of *Enable Modbus RTU(RS485)* the Modbus is enabled.

By pressing *Set to Default* the default values will be set.

Default values: Baudrate: 19200
Stoppbit: 1
Parity: even

In case that the DS400 is the end of the RS485 bussystem with activating *Term-* & *Bias-* button the required termination and biasing could be activated.

By pressing *TCP* or *RTU* you are able to change the word order of the data.

Default value for both is C-D-A-B

Every change have to be confirmed by pressing *Apply* – button.

Device-Settings (Relay settings)

13.2.3.5 Relay Settings

Main menu → Settings → Device settings → Relais-Settings

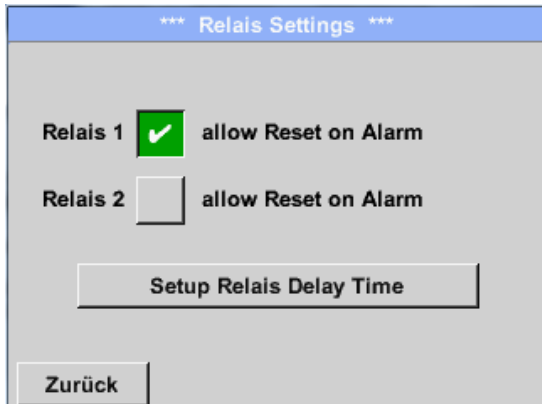

By activated *relais* button it is allowed / possible to turn off the corresponding alarm relays in the popup appearing in alarm case.

Setting is only possible in the password protected *Device Settings* menu.

Default values at delivery are **not allowed** .



In an alarm case e.g. here alarm 1(Yellow) for channel A1 a popup will be displayed.

If in the Relay Settings the turning off of Relay 1 was allowed by pressing Relay 1 button switches this off.

By confirming with OK the popup will be closed.

13.2.3.6 SD-Card

Main menu → Settings → Device settings → SD-Card → Reset Logger Database

Main menu → Settings → Device settings → SD-Card → Erase SdCard

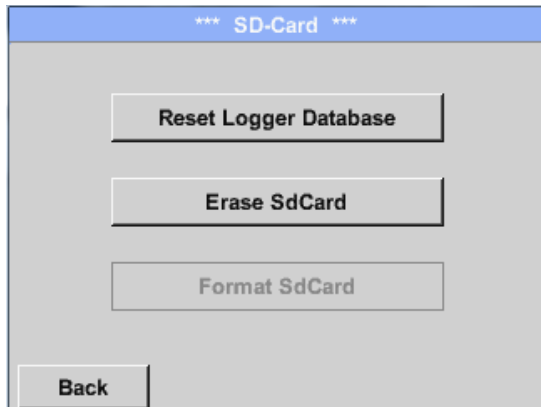

By pressing *Reset Logger Database* all actual stored data on SD-Card will be blocked for use in DS 400. Nevertheless all data are still stored and available for external use only.

By pressing *Erase SdCard* all Data on the SD-Card will be deleted.

System

13.2.3.7 System

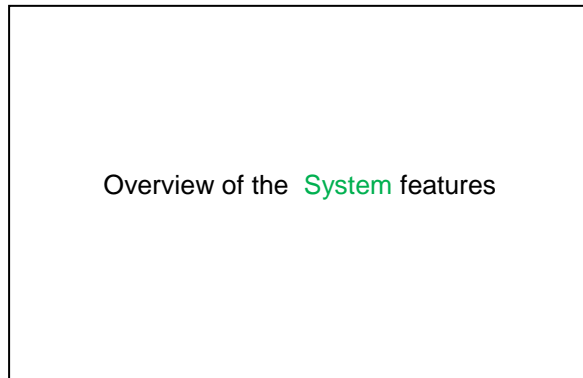
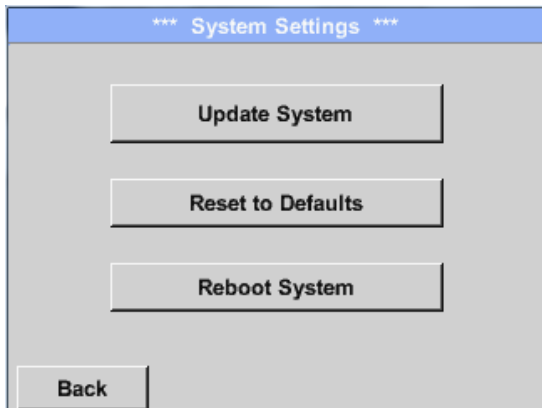

13.2.3.7.1 Save system settings

Important:

Before updating the DS 400 the system settings should be secured either on a USB or the internal SD-Card!

Home → Import / Export → Export System Settings

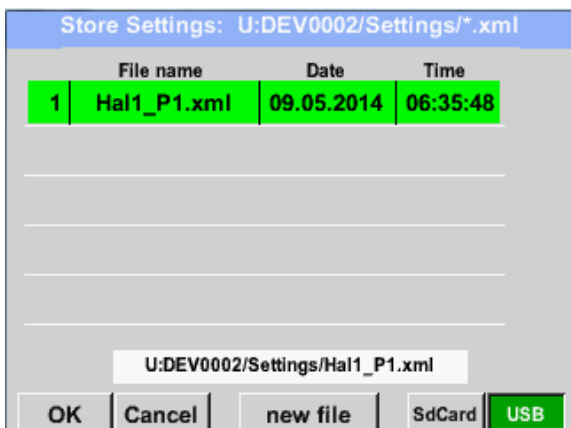

With Export system settings, all existing sensor settings can be exported to a USB stick or to the internal SD card. It stores all sensor settings including recording-, alarm-, graphics-, value- and name definitions. Storing location could be selected using the buttons **SD card** or **USB**.

Either a new file could be created by pressing "new file" or an existing file overwritten by selecting a name from the list.

The data are stored after confirmation with **OK**.

13.2.3.7.2 System update

Home → Settings → Device settings → System-Update

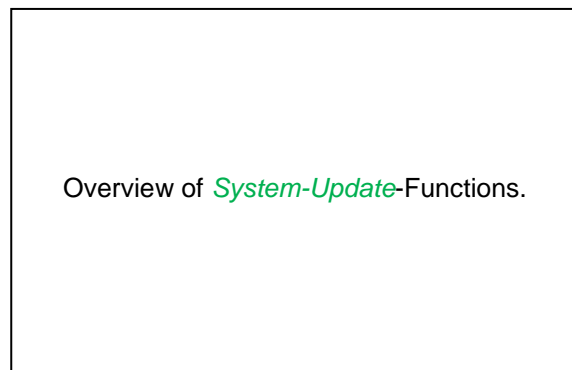
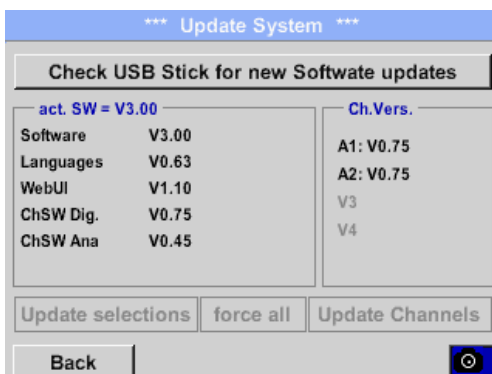

System / System update

13.2.3.7.3 Check for Updates

Home → Settings → Device settings → System-Update → check USB-Stick for new Updates

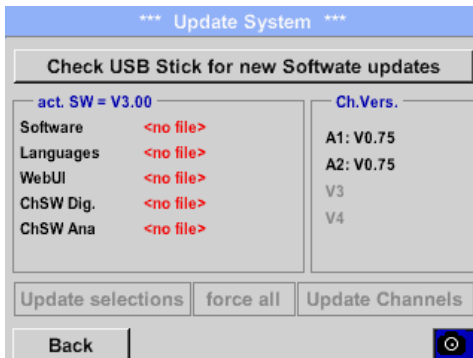

If after pressing the button “*Check USB Stick for new Software updates*” the following messages appear in the window, is the DS 400 is not properly connected to the USB flash drive or there are no files available.

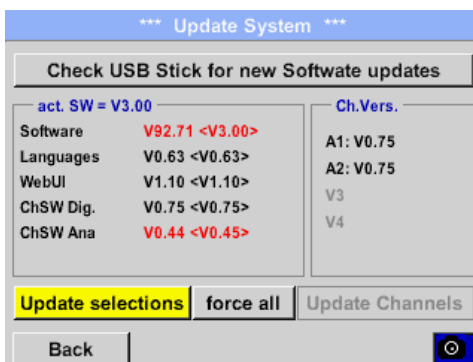

Is the DS 400 properly connected to the USB drive and there are new versions of the individual software parts available, then they are in red font and <new> marked.

If it is required to install an older software version, you have press the button "Force all ".

13.2.3.7.4 Update Firmware

Home → Settings → Device settings → System-Update → Update-Firmware

The update of DS 400 for all new SW parts starts.

Important:

If the *Reboot system* button appears after the update, it must be pushed to restart the DS 400!

13.2.3.7.5 Update Channels

Home → Settings → Device settings → System-Update → Update-Channels

The update of DS 400 channels starts.

Important:

If the *Reboot system* button appears after the update, it must be pushed to restart the DS 400!

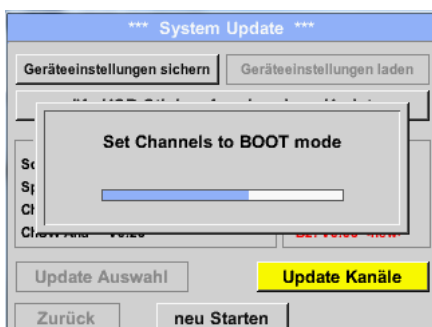

Update for Channels DS 400.

System / Factory reset

13.2.3.7.6 Factory Reset

Main menu → Settings → Device settings → System → Reset to Defaults

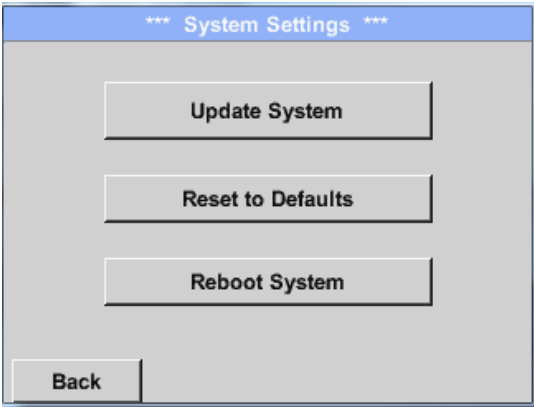
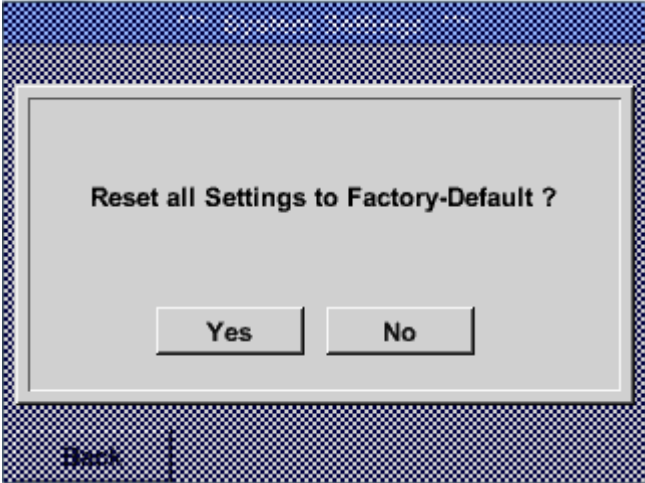

Reboot the *System* here, if you need it!

13.2.3.8 Calibrate touch-screen

Main menu → Settings → Device settings → calibrate touchscreen

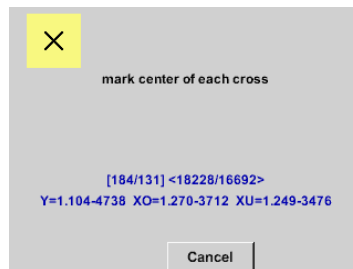
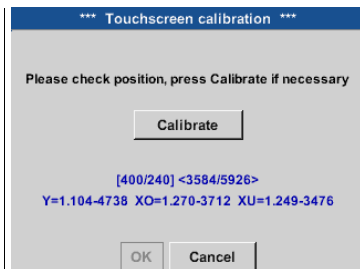

If necessary, the touch-screen calibration can be changed here. Push *Calibrate* and it appears, 1. left above, 2. bottom right, 3. bottom left, 4. right above and 5. in the middle, a calibration cross that must be pushed consecutively. If the calibration finished positive a message "*Calibration successful*" appears and have to be confirmed with *OK*. Is this not the case, so you can repeat the calibration with the help of the *Cancel* and *Calibrate* buttons.

13.2.4 Set backlight

Main menu → Settings → Helligkeit

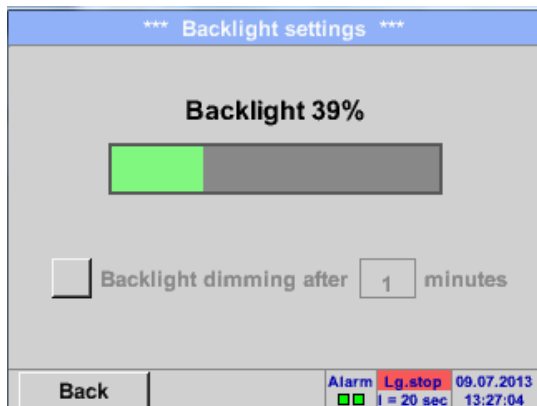

Here you adjust the desired *Backlight* (15-100%) of the display directly.

E.g. *Backlight* to 39 %

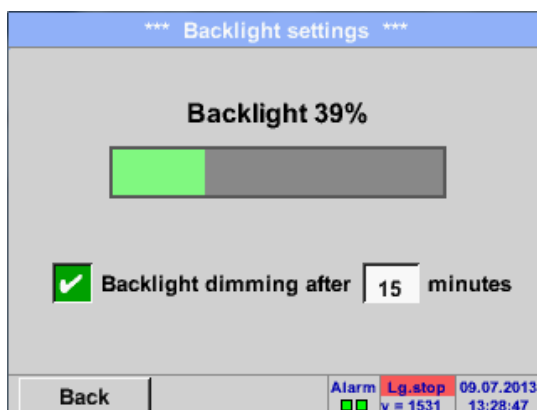

With the help of the *Backlight dimming after* button, after a definable time interval (here after 15 minutes), the *Backlight* can be reduced to the minimum.

As soon as the dimmed screen is operated again, the *Backlight* is committed automatically on the last set value before dimming.

Remark:

At the first touch, the *Backlight* in our example is reset to 39%, after that a "normal" function operation is possible.

Important:

If the *Backlight dimming after* button is not activated, then the *Backlight* stays permanently on, in the currently set brightness.

13.2.5 Cleaning

Main menu → Settings → Cleaning



This function can be used for cleaning the touch panel during running measurements.

If one minute is not enough time to clean, the process can be repeated at any time.

Is the cleaning faster finished, then you can push the *to abort press long* button (for one or two seconds) to cancel.

13.2.6 System-Status

Main menu → Settings → System-Status

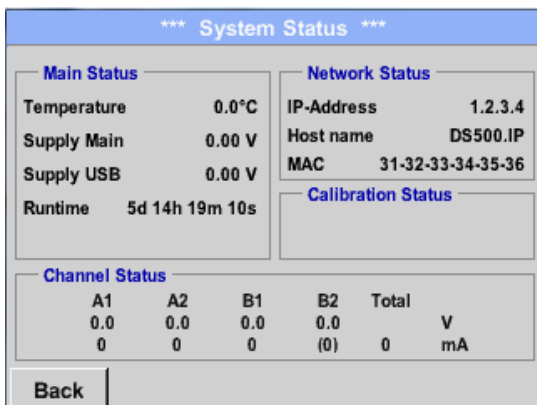

The function **System Status** offers an overview, fitting voltages and currents on the individual and the entire channels, as well as the power supply of the power supply units.

In addition, it offers the most important network information, such as *IP*, *host name* and *MAC*.

By the *Runtime*, you always know how long the DS 400 was in total in operation.

13.2.7 About DS 400

Main menu → Settings → About DS 400

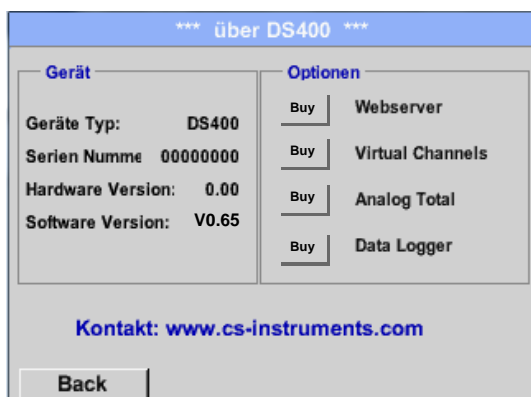

Brief description of the **Hardware** and **Software Version**, as well as the **Serial Number** of the DS 400.

Under options, you can buy four additional, different functions, if you have not done this by ordering.

13.2.8 Virtual Channels (optional)

The option „Virtual Channels“ offers 4 additional channels (no HW Channels) where it is possible to display calculations of each single HW-Channel, virtual channels and free defined constants as well. For each „Virtual Channel“ are 8 calculations each with of 3 operands and 2 operations possible.

Possible cases are calculation of:

- Specific performance of a compressor(s)
- Complete consumption of a compressor(or the sum of several compressors)
- Energycost etc.

An example for a specific performance calculation see chapter [12.2.6.6](#)

13.2.8.1 Option „Virtual Channels“ activation

After purchasing of the option „Virtual Channels“ the functionality have to be activated first.

Main menu → Settings → About DS 400

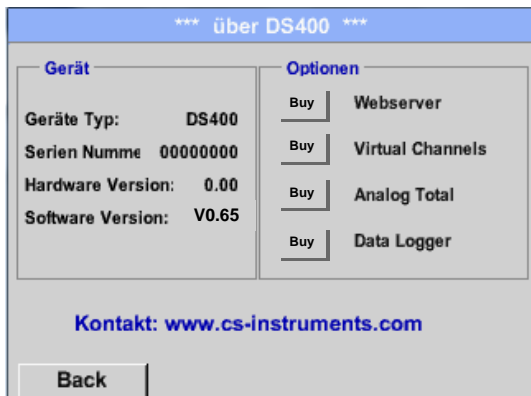

Please push the button Buy for „Virtual Channels“ and you will requested to insert the key-code received

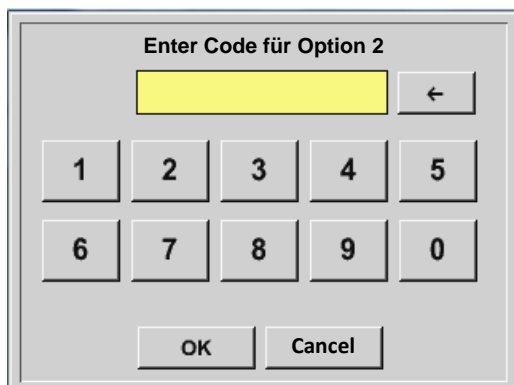

Please enter the Key-Code in the text-field and activate the option by pushing the button **OK**

Virtual Channels

13.2.8.2 Virtual Channels Einstellung

Main menu → Settings → Sensor Settings → Virtual Channels

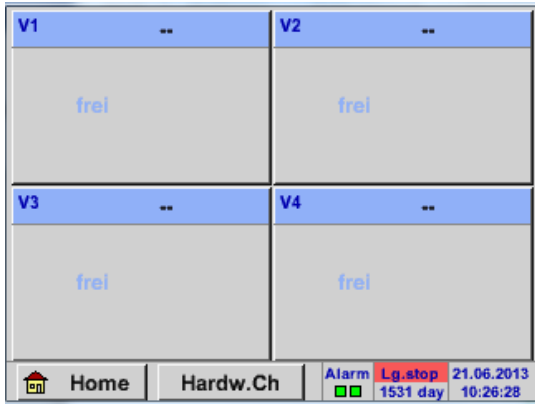

After pushing the button „*Virtual Channels*“ in the Sensor Settings menu an overview with the 4 available “*Virtual Channels*” is displayed.

Remark:
By default, all channels are without settings.

13.2.8.3 Selection of Sensor-type

Main menu → Settings → Sensor Settings → Virtual Channels → V1

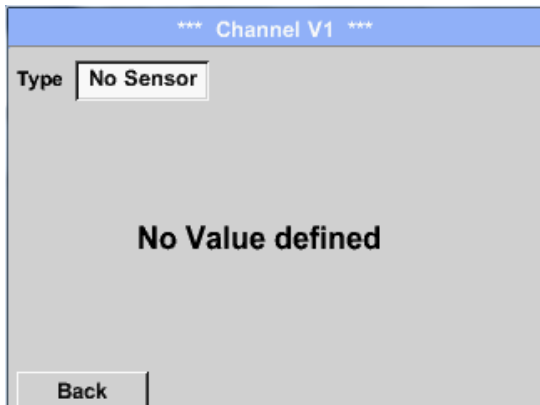

By pushing the description field *Type No Sensor* the list of sensor types appears (see next step).

Main menu → Settings → Sensor Settings → Virtual Channels → V1 → Type description field

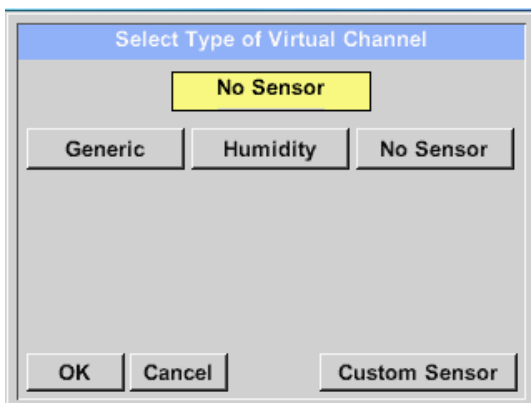

If still no sensor has been configured, the *Type No Sensor* appears.

By pushing the button **Generic** the virtual channel is selected.

With **Custom Sensor**, a predefined sensor-setting could be loaded, see also [chapter 12.2.2.12](#)

Pushing the button **No Sensor** will reset the virtual channel.

Confirmation of selection is done by pressing the button **OK**.

Virtual Channels

Main menu → Settings → Sensor Settings → Virtual Channels → V1 → Name description field

By pushing the Text field *Name* a Sensor name could be inserted.

13.2.8.4 Configuration of each single virtual value

Each virtual channel includes 8 individual calculated values where every value has to be activated separately.

13.2.8.4.1 Activation of a single virtual value

Main menu → Settings → Sensor Settings → Virtual Channels → V1 → arrow right(2.page) → V1a → Use

Every virtual value has to be activated by selecting the respective *Value-Button* e.g. *V1a* and pushing of the *Use Button*.

13.2.8.4.2 Definition of Operands

Main menu → Settings → Sensor Settings → Virtual Channels → V1 → arrow right(2.page) → 1stOperand

By accessing the text field *1st Operand* The list with all channels (HW and virtual channels) and const. Value appears.

Virtual Channels

Main menu → Settings → Sensor Settings → Virtual Channels → V1 → arrow right(2.page) → 1stOperand → A1

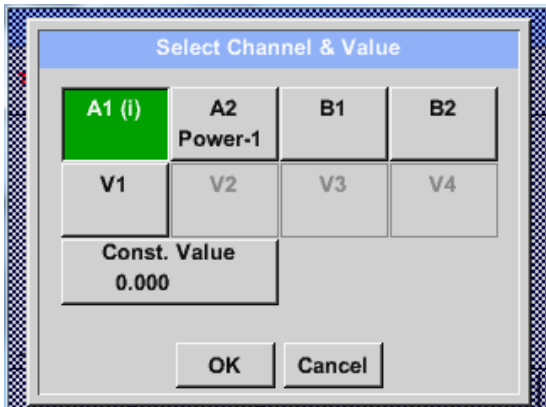

By pressing a button either for HW-, virtual channel or const. Value e.g. *A1* a list of all available measurement channels or measurement values will appear.

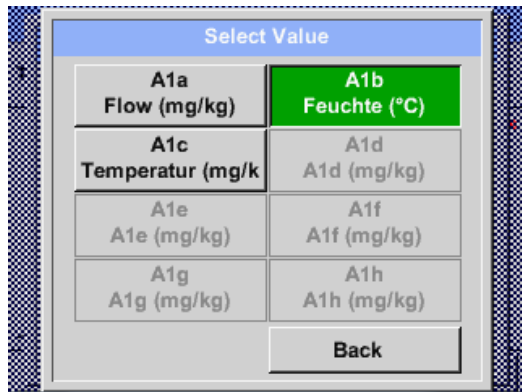

Pressing the respective channel button e.g. *A1b* will select the measurement channel

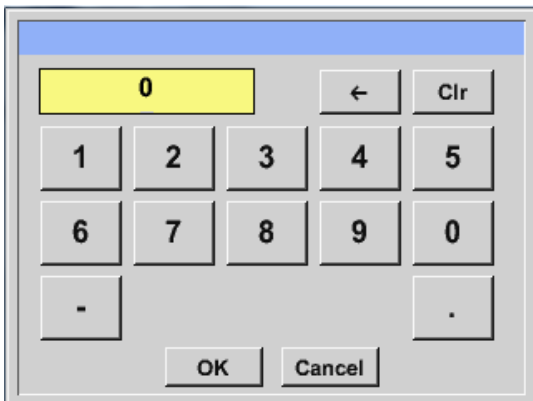

Pressing the button *const. Value* requests the input of the *const. Value* into the text field.

With button *OK* the value will validated

With the buttons ← and *Clr* it is possible to correct the input.

Button ← deletes the last figure

Button *Clr* clears the whole field

This approach is analogous to the other operands. (1st Operand, 2nd Operand and 3rd Operand) .

Virtual Channels

13.2.8.4.3 Definition of Operations

Main menu → Settings → Sensor Settings → Virtual Channels → V1 → arrow right (2.page) → 1st Operation

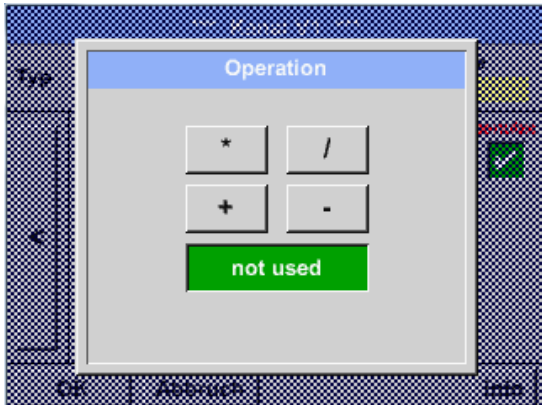

By accessing the text field *1st Operation* the list with all available operands appears.

Selecting and validation of the operand by pressing the respective operand.

Pressing of the button *not used* deactivates the operation of the dedicated operand.

This approach is analogous for both operations (1st Operation and 2nd Operation)

13.2.8.4.4 Definition of Unit

Main menu → Settings → Sensor Settings → Virtual Channels → V1 → arrow right (2.page) → Unit

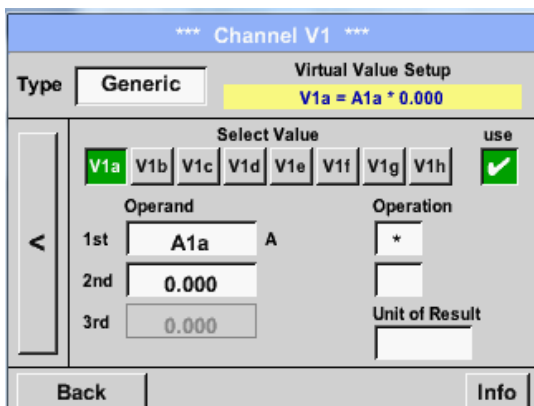

By accessing the text field *Unit of Result* the list with all available units appears

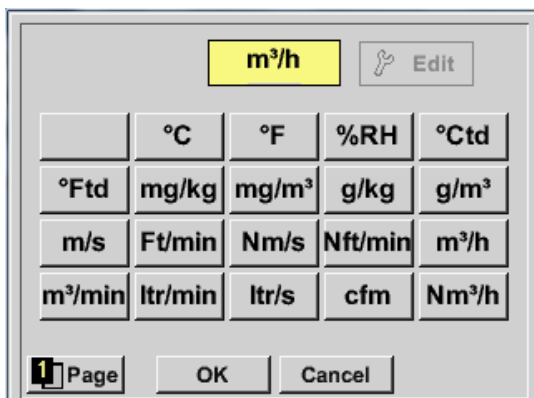

Please select the unit by pressing the respective button e.g. *m³/h*.
For validation of the unit, please push the button *OK*.
To move through the list please press the button *Page*.
In case the unit is **not** available, it is possible to create a user-defined unit.
Therefore, please select one of the *User_X* buttons.

Virtual Channels

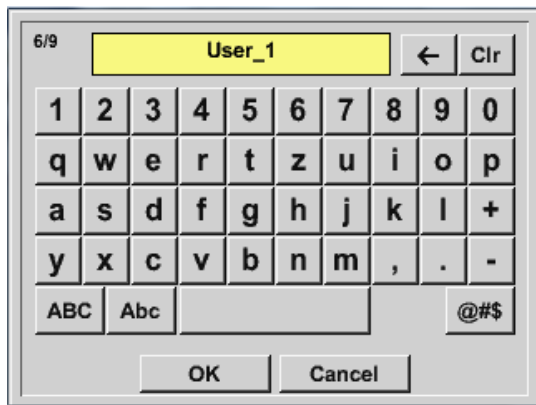

By pressing the button *Edit* you enter the menu for inserting the new Unit.

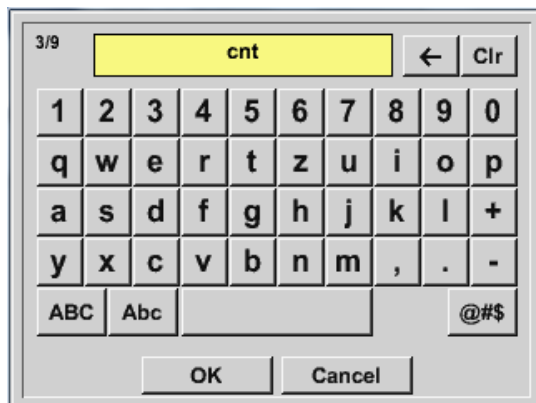

Then define the unit and confirm it with the button *OK*.

With the buttons *←* and *Clr* it is possible to correct the input.

Button *←* deletes the last figure

Button *Clr* clears the whole field

Important

Each calculation allows you the use of maximum 3 operands and 2 operations.

The calculation is then based on following formula:

Example: **V1a = (1st Operand 1st operation 2nd Operand) 2nd operation 3rd Operand**

$$\mathbf{V1a = (A1c - A2a) * 4.6}$$

Virtual Channels

13.2.8.5 Value name, resolution of decimal places and recording of values

Main menu → Settings → Sensor Settings → Virtual Channels → V1 → Tool-Button



The *Resolution* of the decimal places, the *Short Name* and *Value Name* are found under the **Tool button**

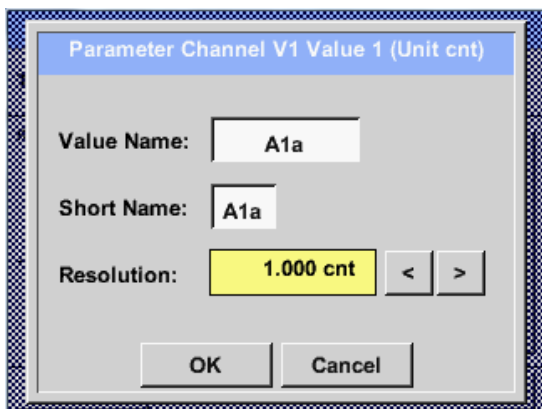

For the recorded *Value* there can be entered a *Name* with 10 characters and later in menu item *Graphics/Real time values* it is easier to identify it.

Default names are e.g. *V1a*.
V1 is the Channel name, *a* is the first measuring value of channel V1, *b* is the second measuring value and *c* the third etc.

The *Resolution* of the decimal places is simply adjustable by pushing right and left

Main menu → Settings → Sensor Settings → Virtual Channels → V1 → Record Button



Use the *Record* buttons to select the measurement data that will be stored by **activated data logger**.

Attention:

Before the selected measurement data are recorded, the data logger must be activated after the settings (See chapter 12.2.12 Logger settings (data logger)).

See also chapter 12.2.2.2 Name the measurement and 12.2.2.3 Recording measurement data

Virtual Channels

13.2.8.6 Calculation Example „Specific Performance“

As an example we assume a compressor system with 3 single compressors.

The consumption measurements are done with consumption sensors VA400 at the inputs A1 – B1 & and an electric meter at input B2.

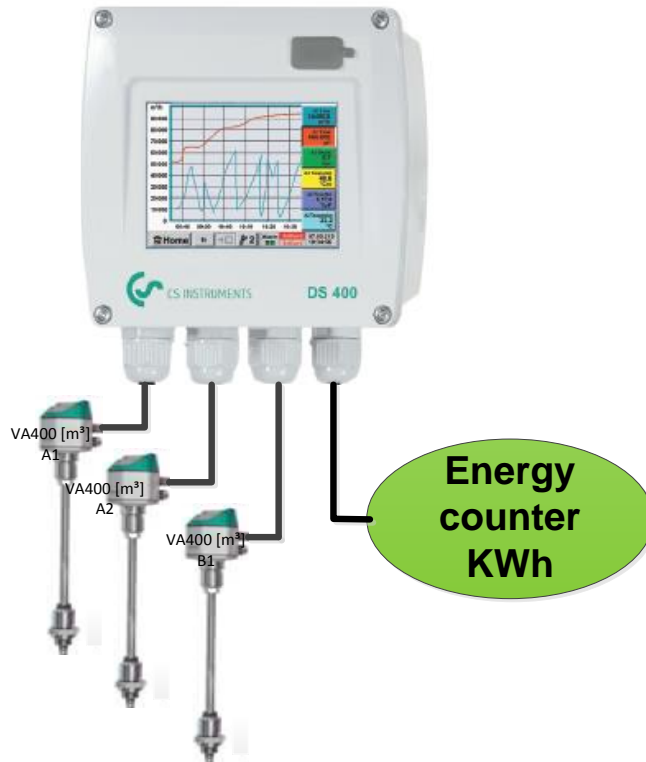

Calculated are the complete consumption of air and energy as well as the "specific performance" of the entire system .

Main menu → Settings → Sensor Settings → Virtual Channels → V1 → arrow right (2.page) → V1a → Use

Type		Generic		Virtual Value Setup							
				$V1a = (A1b + A2a) + B1a$							
		Select Value				use					
		V1a	V1b	V1c	V1d	V1e	V1f	V1g	V1h	<input checked="" type="checkbox"/>	
		Operand		Operation							
		1st	A1b	°C		+					
		2nd	A2a	cfm		+					
		3rd	B1a	cfm			Unit of Result		m ³		
Back											Info



Selection and Input of the operands and operations see chapter [12.2.5.4.2](#) and chapter [12.2.5.4.3](#).

Result in *V1a* is the sum of consumption sensor *A1 + A2 + B1* see range "result".
For this example it is *66090,2 m³*

Virtual Channels

*** Channel V1 ***

Typ **Generic** Name **Anlage Halle3**

Aufzeichnen		Alarm
<input type="checkbox"/>  V1a	66090.2 m ³	<input type="checkbox"/>
<input type="checkbox"/>  V1b	4720.75 kWh	<input type="checkbox"/>





OK Cancel Info

Result in **V1b** is the energy consumption read out from the energy counter.

V1a → complete Air consumption
V1b → energy consumption

*** Channel V1 ***

Typ **Generic** Name **Anlage Halle3**

Aufzeichnen		Alarm
<input type="checkbox"/>  V1a	66090.2 m ³	<input type="checkbox"/>
<input type="checkbox"/>  V1b	4720.75 kWh	<input type="checkbox"/>
<input type="checkbox"/>  sp. Leist.	0.0714 kWh/m ³	<input type="checkbox"/>
<input type="checkbox"/>  Kosten	991.36 €	<input type="checkbox"/>

OK Cancel **1** 1..4 Info

Calculation of the *specific. Perfor.* Is done in **V1c** with $V1c = V1b / V1a$
For this example, it is 0,072 kWh/m³





Calculation of energy cost complete in **V1d** with $V1d = V1b * 0.21$. For this example it is 991,36 €

Energy cost per m³ produced air is done in **V1e** with $V1e = V1c * 0.21$

Due to more as 4 values used in virtual channel V1 the result range is splitted into 2 pages. To move between the pages please press the *page button*

*** Channel V1 ***

Typ **Generic** Name **Anlage Halle3**

Aufzeichnen		Alarm
<input type="checkbox"/>  V1a	66090.2 m ³	<input type="checkbox"/>
<input type="checkbox"/>  V1b	4720.75 kWh	<input type="checkbox"/>
<input type="checkbox"/>  sp. Leist.	0.0714 kWh/m ³	<input type="checkbox"/>
<input type="checkbox"/>  Kosten	991.36 €	<input type="checkbox"/>

OK Cancel Info

*** Channel V1 ***

Typ **Generic** Name **Anlage Halle3**

Aufzeichnen		Alarm
<input type="checkbox"/>  Cost/m ³	0,015 €/m ³	<input type="checkbox"/>

OK Cancel **2** 5..8 Info

Analog-Total

13.2.9 Analog Total (optional)

The Option „**Analog Total**“ offers the possibility of a consumption measurement also for sensors with analogen outputs e.g.: 0-1/10/30V and 0/4 – 20mA.

13.2.9.1 Option „Analog Total“ activation

After purchasing of the option „Analog Total“ the functionality has to be activated first.

Main menu → Settings → about DS 400

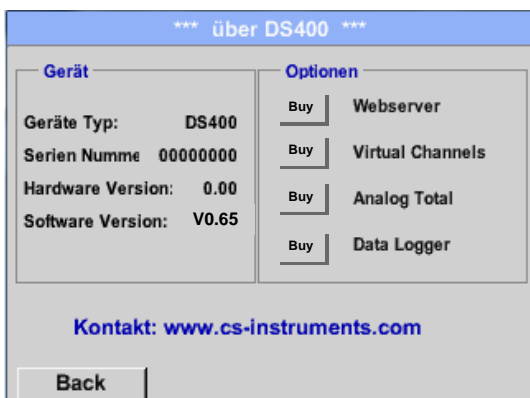

Please push the button *Buy* for „Analog Total“ and you will be requested to insert the key-code received

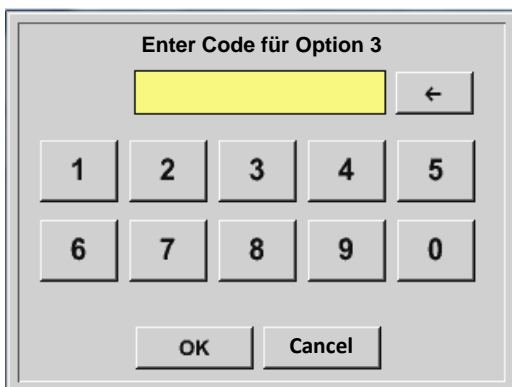

Please enter the Key-Code in the text-field and activate the option by pushing the button *OK*.

Analog Total

13.2.9.2 Selection of sensor type

See also chapter [12.2.2.8 Configuration of analog sensors](#)

Main menu → Settings → Sensor Settings → B1



If still no sensor has been configured, the *Type No Sensor* appears.

By pushing the description field *Type No Sensor* the list of sensor types appears (see next step).

Main menu → Settings → Sensor Settings → B1 → Type description field

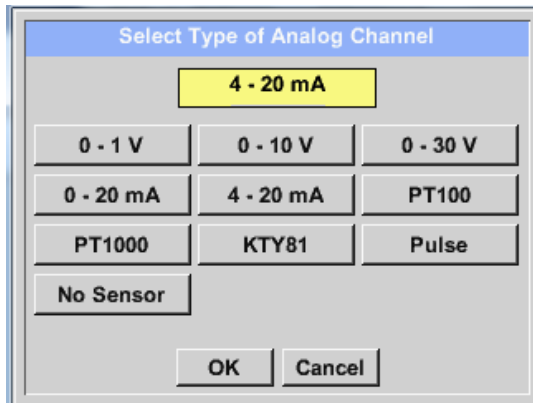

By pushing the button of the required sensor button e.g. 4 -20mA the sensor is selected. Pushing the button **No Sensor** will reset the selection.

Confirmation of selection is done by pressing the button **OK**.

Main menu → Settings → Sensor Settings → B1 → arrow right (2.page)

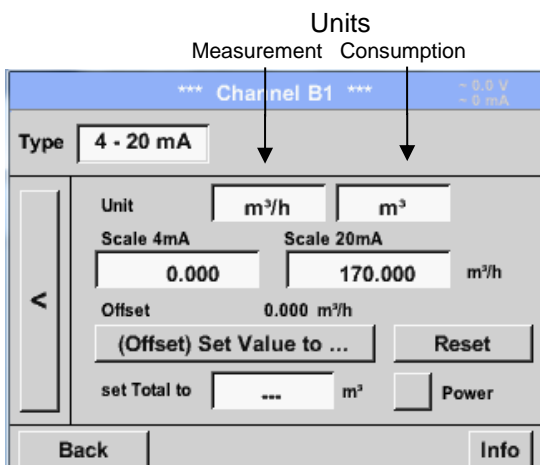

Selection of the units by pushing the text fields for the corresponding measurement and consumption units.

In addition, you can push the *scale buttons* for the min. and max. scaling values and set the measuring range.

Here we have *0 m³/h* for 4 mA and *170m³/h* for 20mA

In addition it is possible to enter a starting value for consumption entering *set Total to* field e.g. to take over value from an old counter.

Confirmation of the inputs by pushing button **OK**

Remark:

The textfield „Unit-Consumption“ is only editable in case of measurement values(Units) with volume per time unit and thus also the consumption calculation.

For labeling and setting of the description fields see also chapter [12.2.2.7 Label and set the description fields](#)

13.2.10 Webserver (optional)

With the web server you have access, worldwide, to the DS 400 system information, the measurement data, the possibility to start the logger and also to install an e-mail notification in case of measurement exceedances (alarms).

The individual functions are accessible via different user levels, every level is protected.

The allocation of access rights is done by the system administrator.
Overview access permissions see chapter [12.2.10.4](#).

After purchasing of the option „Webserver“ the functionality have to be activated first.

13.2.10.1 Option „Webserver“ activation

Main menu → Settings → about DS 400

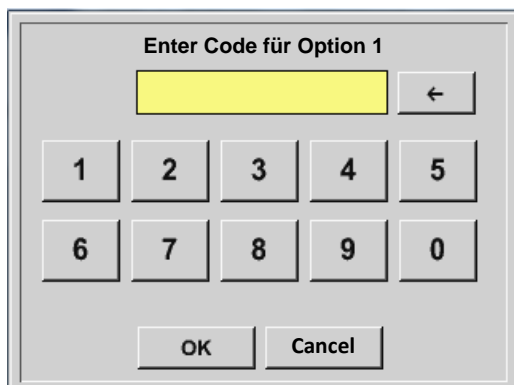
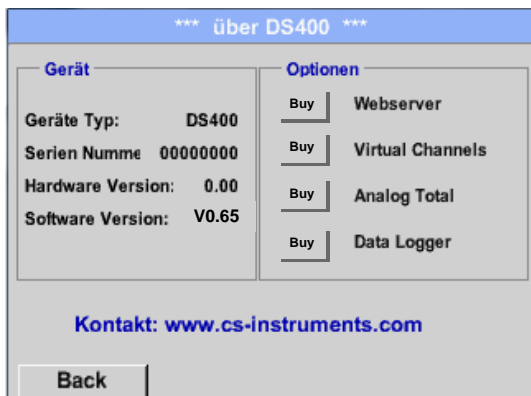

Please push the button *Buy* for „Webserver“ and you will be requested to insert the key-code received

Please enter the Key-Code in the text-field and activate the option by pushing the button *OK*.

Webserver

13.2.10.2 Setup the Webserver Admin Password

The setup of the Web Admin password is done under

Home → Settings → Device Settings → Network Settings

*** Network settings ***

IP address via DHCP

IP address: 1.2.3.4 Subnet Mask: 0.255.255.255

Gateway address: 1.2.3.4 DNS address: 1.2.3.4

Host name: D4-0787 HTTP Port: 80

WebAdmin Password: 12345678

Back Apply & Restart

In the text description field *WebAdmin Password* could the password be set up. The password length is ≥ 8 characters.

Takeover by pressing *Apply & Restart*.

13.2.10.3 Webserver start

With an Internet-Explorer (IE, Firefox, Chrome) and the IP-address of your DS 400, you can access the webserver.

http:// <IP-address of the DS 400>

Remark:

The IP-address of the DS 400 you can see in the chapters [12.2.6 System Status](#) and [12.2.2.3 Network settings](#)

Webserver Startwindow Info:

CS INSTRUMENTS GmbH DS400 09.04.2015 - 10:14:04 Visits: 1 User: --- Login

english

Info Favourites

System Information

System Information	
Brandname	DS400
Company	CS Instruments
Serialnumber	40130024
Hardware Version	V1.21
Software Version	V92.60
Channel Version Analog	V0.43
Channel Version Digital	V0.75
Language Version	V0.61
WebUI Version	V1.06
Total Channels	4
Hostname	D4-0024
Calling IP	192.168.172.19
Logger State	run
Alarm State	OK

visit CS Instruments

No access rights are required, see [Chapter 12.2.10.4](#)

Webserver

13.2.10.4 Webserver assignment of rights (Administrator)

13.2.10.4.1 Accessrights Webserver

For individual functions, appropriate privileges are required, see table "access rights"

Rights Group	Info	Status	Actuals	Chart	MailonAlarm	Settings User/Mail
w/o	X					
Guest	X	X	X			
User	X	X	X	X		
Operator	X	X	X	X	X	
Admin	X	X	X	X	X	X

Table Accessrights

13.2.10.5 Webserver Login

After pressing the Button « Login » following screen is visible.

Login as Administrator with Username «admin» and the WebAdmin Password.

Setup of the WebAdmin Passwords see [Chapter 12.2.10.2](#)

The screenshot shows the DS400 webserver interface. At the top, there is a green header bar containing the CS INSTRUMENTS GmbH logo, the text 'DS400', and a status bar with the date '10.04.2015 - 12.49.20', 'Visits: 1', and a 'Login' button. Below the header, there is a language dropdown menu set to 'english'. On the left side, there is a vertical menu with the following items: Info, Favourites, Status, Actuals, Screen, Chart, MailOnAlarm, Users/Passw, EMail Config, and Testpage. The main content area is a white box with a yellow header 'Login'. Inside this box, there are two input fields: 'Username' and 'Password', and a 'submit' button. At the bottom of the page, there is a yellow footer bar with the text 'visit CS Instruments'.

After starting as Administrator all the functions on the left side are activated.

13.2.10.6 New users and password

Selection of function « **User/Passw.** » (only for Administrators accessible)

The screenshot shows the DS400 webserver interface. The top header includes the CS INSTRUMENTS GmbH logo, the text 'DS400', and a status bar with the date '10.04.2015 - 13:01:23', 'Visits: 1', and 'User: admin Logout in: 14:04'. A left sidebar contains navigation links: 'english', 'Info', 'Favourites', 'Status', 'Actuals', 'Screen', 'Chart', 'MailOnAlarm', 'Users/Passw', 'EMail Config', and 'Testpage'. The main content area displays the 'User & Password Setting' form, which is a table with three columns: 'Username', 'Password', and 'Group'. The table contains the following entries:

Username	Password	Group
Guest	••••	Visitor
Operator1	••••••	Operator
Admin12		Administrator
		Visitor
		Visitor
		Visitor

At the bottom of the form are 'Submit' and 'Refresh' buttons. A footer at the bottom of the page says 'visit CS Instruments'.

With this function you are able to define the users with their corresponding accessrights.

Username : min. 4 characters; max. 12 characters

Password : min. 4 characters, max. 12 characters

Group : see accessrights chapter 12.2.10.4

The inputs will be stored with « **Submit** »

13.2.10.7 Webserver E-Mail Configuration (Administrator)

Access of function « **EMail** » only for administrators

In case you are not logged in as administrator, please see [chapter 12.2.10.4.2](#)

At the first/ initial configuration there are no entries.

The screenshot shows the DS400 webserver interface. The top header includes the CS INSTRUMENTS GmbH logo, the text 'DS400', and a status bar with the date '10.04.2015 - 13:10:40', 'Visits: 1', and 'User: admin Logout in: 14:31'. A left sidebar contains navigation links: 'english', 'Info', 'Favourites', 'Status', 'Actuals', 'Screen', 'Chart', 'MailOnAlarm', 'Users/Passw', 'EMail Config', and 'Testpage'. The main content area displays the 'EMail Configuration' form, which is a table with two columns: 'Field' and 'Value'. The table contains the following entries:

Field	Value
from	DS400@cs-instruments.com
to rep 1	KH.frank@cs-instruments.com
to rep 2	
Mail Account ServerName	smtp.1und1.de
SMTP Port	587
need Authentication	<input checked="" type="checkbox"/>
Mail Account User	DS400@cs-instruments.com
Mail Account Password	••••••

At the bottom of the form are 'Test EMail setting', 'Submit', and 'Refresh' buttons. A footer at the bottom of the page says 'visit CS Instruments'.

An existing mail account and those accessdata are needed for final mail configuration.

Webserver

EMail Configuration	
from	<input type="text" value="DS400@cs-instruments.com"/>
to rcp 1	<input type="text" value="KH.frank@cs-instruments.com"/>
to rcp 2	<input type="text"/>
Mail Account ServerName	<input type="text" value="smtp.1und1.de"/>
SMTP Port	<input type="text" value="587"/>
need Authentication	<input checked="" type="checkbox"/>
Mail Account User	<input type="text" value="DS400@cs-instruments.com"/>
Mail Account Password	<input type="password" value="*****"/>
<input type="button" value="Test EMail setting"/>	
<input type="button" value="Submit"/> <input type="button" value="Refresh"/>	

from: mail username
to rcp 1: mail Address recipient 1
to rcp 2: mail Address recipient 2
Mail-Account Servername: Name of SMTP
Mail output server of your provider
Mail Account User: mail Address of user
Mail Account Password: user password of mail account

It is possible to define max. 2 mail recipients.

The settings will be stored by pressing « **Submit** »

A verification (correctness of your settings) could be done by sending a test mail.

Therefore please press the button « **Test EMail setting** »

EMail Test ... OK
see below

MailServer IP = 212.227.15.167
try to Connected
Connected
try auth login
login OK
send header
send body
send quit
tcp_close OK
SMTP-Task ready

Are all settings ok, a message, see left, will be displayed and a mail should be received by the defined recipients.

13.2.10.8 Webserver MailOnAlarm (Administrator & Operator)

This feature allows sending an e mail at limit violations (alarms) to the addresses defined under EMail. Mail delivery's are based on the respective Alamrelais, ie when limits are exceeded and the relais are activated an E-mail will be sent too.

The EMail content is fixed only one short comment could be added.

The screenshot shows the DS400 webserver interface. At the top, there is a green header with the CS INSTRUMENTS GmbH logo and the text 'DS400'. On the right side of the header, it displays the date and time '10.04.2015 - 13:37:09', the number of visits 'Visits: 1', and the user information 'User: admin Logout in 14:57'. On the left side, there is a vertical menu with options: 'english', 'Info', 'Favourites', 'Status', 'Actuals', 'Screen', 'Chart', 'MailOnAlarm', 'User/Passw', 'EMail Config', and 'Testpage'. The main content area displays the 'Alarm EMail Setup' form. The form has a blue header and a table with the following structure:

EMail on Event	to rcpt 1	to rcpt 2	short comment (max 40 chr)	Testmail
Relay #1	<input checked="" type="checkbox"/>	<input type="checkbox"/>	DS400 Test	Send testmail
Relay #2	<input type="checkbox"/>	<input type="checkbox"/>		Send testmail

Below the table is a 'Submit' button. At the bottom of the page, there is a yellow bar with the text 'visit CS Instruments'.

Alarm EMail Setup				
EMail on Event	to rcpt 1	to rcpt 2	short comment (max 40 chr)	Testmail
Relay #1	<input checked="" type="checkbox"/>	<input type="checkbox"/>	DS400 Test	Send testmail
Relay #2	<input type="checkbox"/>	<input type="checkbox"/>		Send testmail

Submit

In this form the recipients for the required alarms could be set/defined.

In addition a short comment could be added. With the button *Submit* the settings are stored.

Alarm Email Content:

DS 400 ALARM

Event: 15.01.2015 13:49:20

IP: 192.168.172.39

Hostname: DE-0529

- Alarm for Relais_1 Level_1 Comment: Test1
 - Channel (A2) "Ch-A2" Value "Temp."
 - Actual = 30.33°C > 30.000°C (Limit ± Hyst.)

End of message

13.2.10.9 Webserver Chart (Administrator, Operator & User)

With these function it is possible to access and view all measurement data stored on the DS400 SD card.

The data are by a continuous recording, on a daily base, else according the used recording period stored.

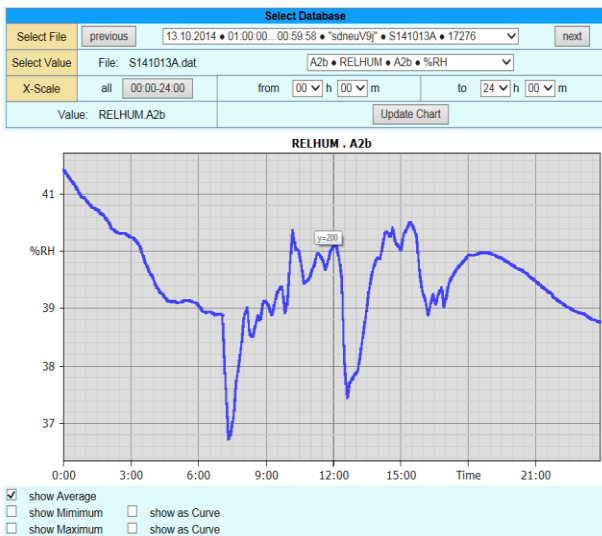
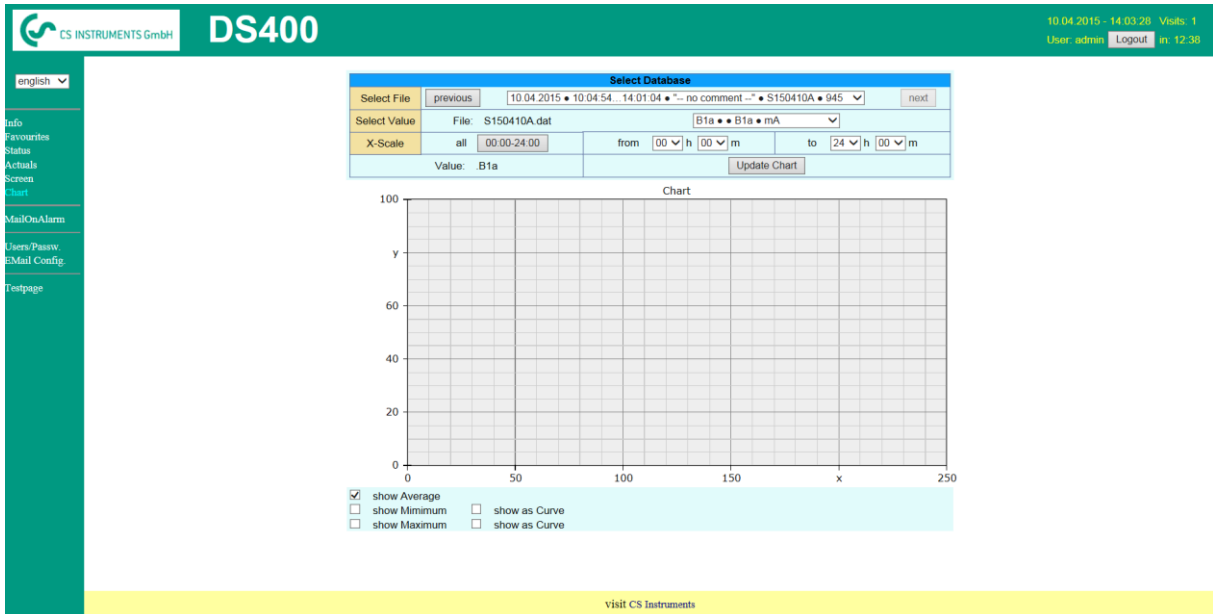

Select File : In this drop down field a measurement data file could be selected. With buttons *previous* & *next* could be switched between the files

Select Value : Here the required measurement value has to selectd

X-Scale : With entering a time in the field «*from*» and «*to*», a specific time span could be defined.

Viewing of data by pressing button *Update Chart*, in addition *show average* must be enabled.

With *show Minimum* and *show Maximum* the min and max values will be displayed too.

With activation of *show as curve* the min and max values will be displayed as curve.

13.2.10.10 Webserver Screen

Herewith it is possible to get a screen copy of the DS400 for Homemenu, Chart/RT, Channels, Realtime values, Alarm and Settings (Systemstatus, about DS 400).

Remark :

Any selection change done through the webserver is transferred to the DS 400 too.

With simultaneous access to the DS 400 by webserver and an operator direct at the DS400 the operator has priority. By simultaneous web access priority is according to accessrights.

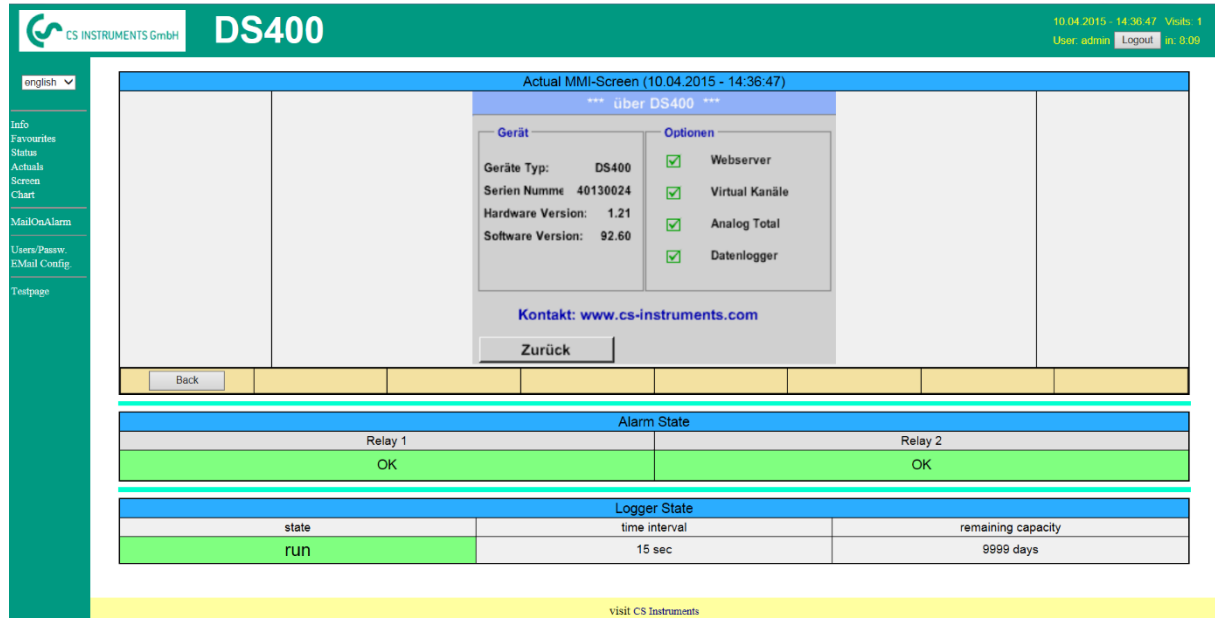

Screen → Chart/RT

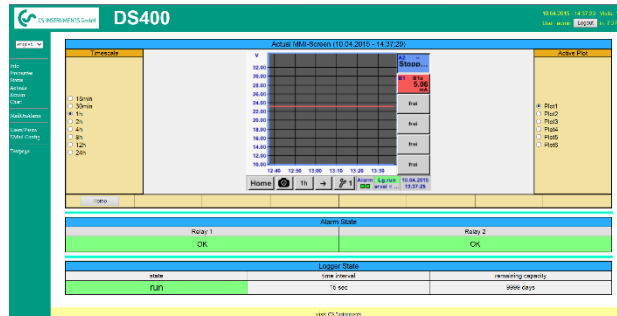

Timescale : The required timespan could be selected

Active Plot : Herewith could one of the defined curves selected where for which the Y-scale will be displayed. A double click will switch on / switch off the corresponding curve

Both function are analogue DS400. By pressing *Home* the screen is going back to the main menu.

Screen → Channels

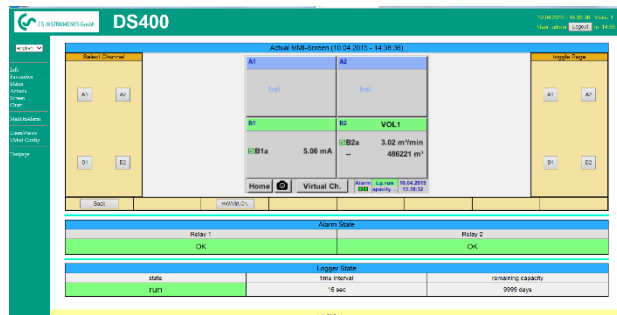

Select channels : Selection of single channel

Page: If the sensor has more as 4 values, by pressing this button you can switch to 2.page.

HW/VirtCh. : Switch to *Virtual Channel*

Settings are analog to DS 400. By pressing *Back* the screen is going back to the main menu.

Selection of the screens

- Realtime)
- Alarm
- Settings

- Screen → Realtime
- Screen → Alarm
- Screen → Settings

is done analog to above

13.2.10.11 Webserver Actuals

The screenshot shows the DS400 webserver interface. The top header includes the CS INSTRUMENTS GmbH logo, the device name 'DS400', and the date/time '10.04.2015 - 14:57:34' with 'Visits: 1' and 'User: admin Logout n: 14:57'. A left sidebar contains navigation options like 'Info', 'Favourites', 'Status', 'Actuals', 'Screen', 'Chart', 'MailOnAlarm', 'Users/Passw', 'EMail Config', and 'Testpage'. The main content area displays 'next Update (1) in 58 sec' and 'Actual Values (10.04.2015 - 14:57:31)'. Below this are two sections: 'show Sensors' with checkboxes for 1, 2, and 3; and 'show Values' with checkboxes for 1 through 8. A table follows with columns for Channel, Value 1 through Value 8. The table data is as follows:

Channel	Value 1	Value 2	Value 3	Value 4	Value 5	Value 6	Value 7	Value 8
S1 (B1)	B1a 6.06 mA	--	--	--	--	--	--	--
S2 (B2)	B2a 3.03 m³/min	486278 m³	--	--	--	--	--	--
S3 (V1)	VOL1 TEST9942	20.25 mA	--	--	--	--	--	--

At the bottom of the table area, there are controls for 'Refresh Time: 60 sec' and 'Font size: try'. A yellow footer bar contains the text 'visit CS Instruments'.

- show Sensor: enable / disable the view for individual sensors
- show values: enable / disable the view for individual sensors values
- Refresh time: Selection of the timespan of the data update (60s, 30s, 10s, 5s, 2s, 1s)
- Font size: Size of characters (4 different sizes)

13.2.10.12 Webserver Status

The screenshot shows the DS400 webserver interface for status monitoring. The top header is identical to the previous screenshot. The left sidebar is also the same. The main content area displays 'Alarm State' and 'Logger State'. The 'Alarm State' section shows two relays, Relay 1 and Relay 2, both with a status of 'OK'. The 'Logger State' section shows three parameters: 'state' is 'run', 'time interval' is '15 sec', and 'remaining capacity' is '9999 days'. A yellow footer bar contains the text 'visit CS Instruments'.

Here you have an overview of Relays and Logger status.

Remark:

In case the logger is stopped, user with access rights of administrator or operator are able to start the logger. To stop the logger is only possible at the DS 400 direct.

Data Logger

13.2.11 Data Logger (optional)

After purchasing of the option „Data logger“ the functionality has to be activated first.

13.2.11.1 Option „Data Logger“ activation

Main menu → Settings → about DS 400

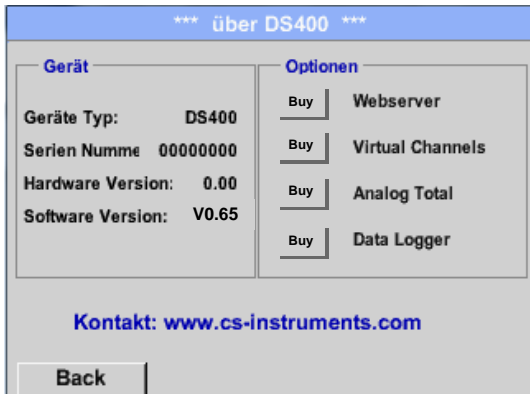

Please push the button *Buy* for „Data logger“ and you will be requested to insert the key-code received

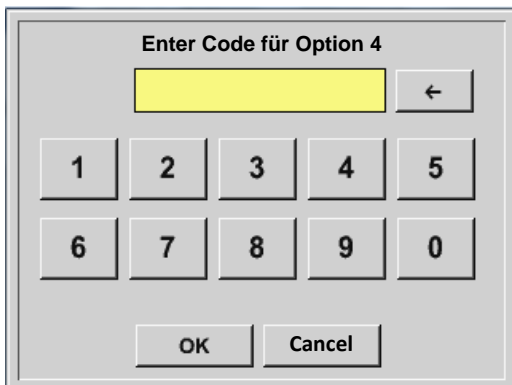

Please enter the Key-Code in the text-field and activate the option by pushing the button *OK*.

13.2.11.2 Data logger Settings

Main menu → Settings → Logger settings

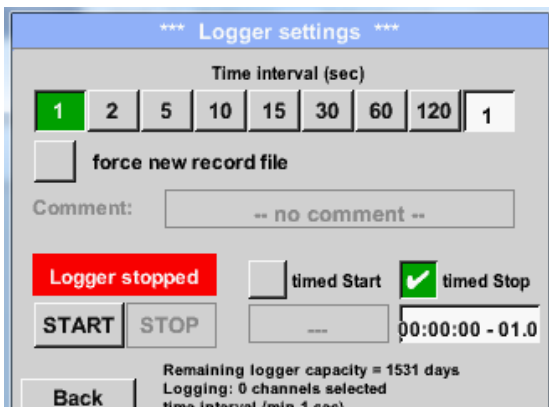

In the top row you can select the predefined *Time intervals* 1, 2, 5, 10, 15, 30, 60 and 120 seconds for recording.

Data Logger

A different, individual *Time interval* can be entered in the highlighted white description field right at the head, where the currently set *Time interval* is always displayed.

Remark:

The largest possible *Time interval* is 300 seconds.

Remark:

If more than 12 measurement data are recorded at the same time, the smallest possible time interval of the data logger is 2 seconds.

And if more than 25 measurement data are recorded at the same time, the smallest possible time interval of the data logger is 5 seconds.

Main menu → Settings → Logger settings → force new Record File button

or

Main menu → Settings → Logger settings → force new Record File button → Comment description field

A new recording file will be created by pushing the *force new record file* button and a name or comment can be entered by the choice of the *Comment* description field.

Important:

If a new recording file should be created, the *force new record file* button must be activated.

Otherwise, the last applied recording file is used.

Data Logger

Main menu → Settings → Logger settings → **timed Start button**

The screenshot shows the 'Logger settings' menu. At the top, it says '*** Logger settings ***'. Below that is a 'Time interval (sec)' section with buttons for 1, 2, 5, 10, 15, 30, 60, 120, and 1. The '1' button is highlighted. Below the time interval is a checked checkbox for 'force new record file'. A 'Comment:' field contains 'Measurement 1'. There is a red 'Logger stopped' indicator. Below that are 'START' and 'STOP' buttons. To the right, there are checkboxes for 'timed Start' (checked) and 'timed Stop' (unchecked). Below these is a date/time field showing '1:02:00 - 10.0'. At the bottom, there is a 'Back' button and some status text: 'Remaining logger capacity = 1531 days', 'Logging: 0 channels selected', and 'time interval (min 1 sec)'.

By pushing the *timed Start* button and then the date/time description field below, the date and the start time can be set for a data logger recording.

Remark:

If the start time is activated, it will automatically be set at the current time plus a minute.

Main menu → Settings → Logger settings → **timed Stop button**

The screenshot shows the 'Logger settings' menu. It is similar to the previous one, but the 'timed Stop' checkbox is also checked. The 'STOP' button is now active. The date/time field below it shows '2:02:00 - 10.0'. The 'Back' button and status text are also present.

By pushing the *timed Stop* button and then the date/time description field below, the date and the stop time can be set for a data logger recording.

Remark:

If the stop time activated, it will automatically be set to the current time plus an hour.

Main menu → Settings → Logger settings → **timed Start button/timed Stop button**
 → **Date/Time description field**

The screenshot shows a 'timed Start' window. At the top, it says 'timed Start'. Below that is a date/time field showing '15 : 11 : 00 21 · 06 · 13'. The '06' is highlighted in yellow. Below the date/time field are two rows of buttons for digits 1-5 and 6-0. At the bottom, there are 'OK' and 'Cancel' buttons.

After pushing the *date/time description field* a window will appear where the yellow marked area of the time or date can always be set and changed.

Data Logger

Main menu → Settings → Logger settings → timed Start button/timed Stop button
 → Date/Time description field → Cal button

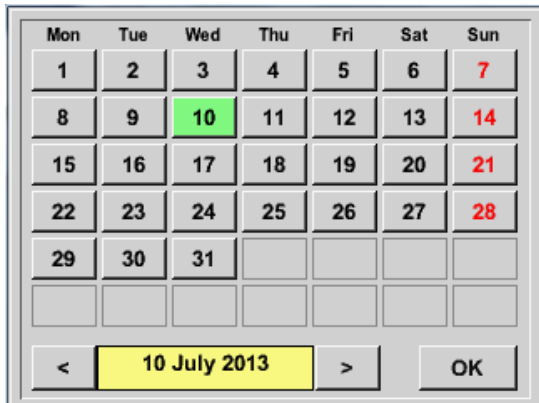

With the *Cal* button, the desired date can be easily select from the calendar.

Main menu → Settings → Logger settings → Start button

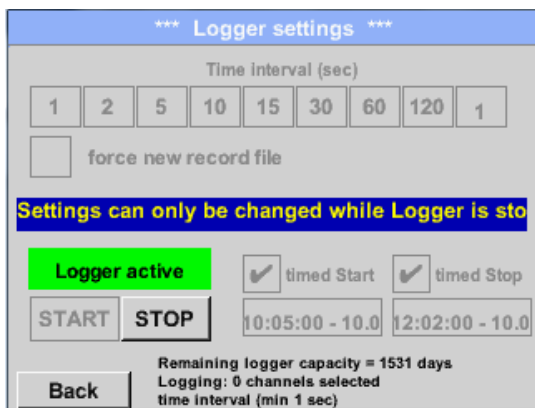

After the start and stop time activation and the created settings, the *Start* button will be pushed and the data logger is armed.

The data logger starts the recording at the set time!

Main menu → Settings → Logger settings → Start button/Stop button

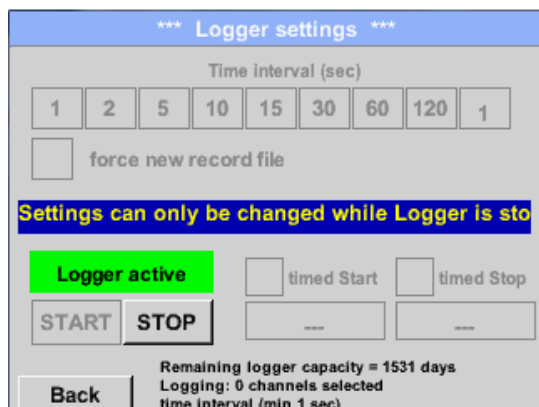

The data logger can be started without activated time settings, use the *Start* and *Stop* buttons for activate and disable. Left below there will be shown how many values are recorded and how long there still can be recorded.

Remark:

The settings cannot be changed, if the data logger runs.

Important:

If a new recording file should be created, the *force new record file* button must be activated. Otherwise, the last applied recording file is used.

Chart

13.3 Chart

Main menu → Chart

Attention:

In the **Chart** there can be represented only records that have already finished!

Current records can be seen in *Chart/Real time values*.

(See [chapter 12.4 Chart/Real time values](#))

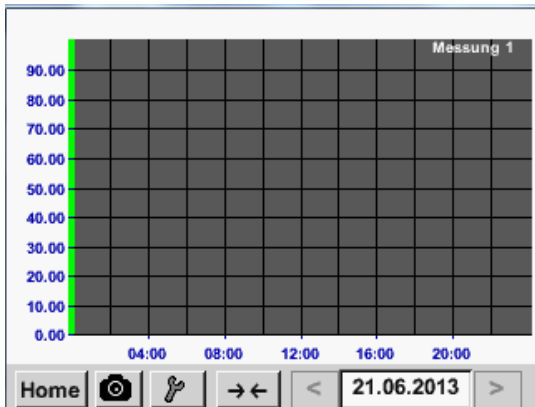

Running measurement, there are no values represented!

Zoom and scroll options in the time domain of the *Chart*:

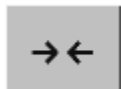

Maximal an entire day can be represented (24h).



The smallest possible range is represented, depending on the time interval of the recording.

Additional zooming and scrolling options in *Chart* and *Chart/Real time values*:

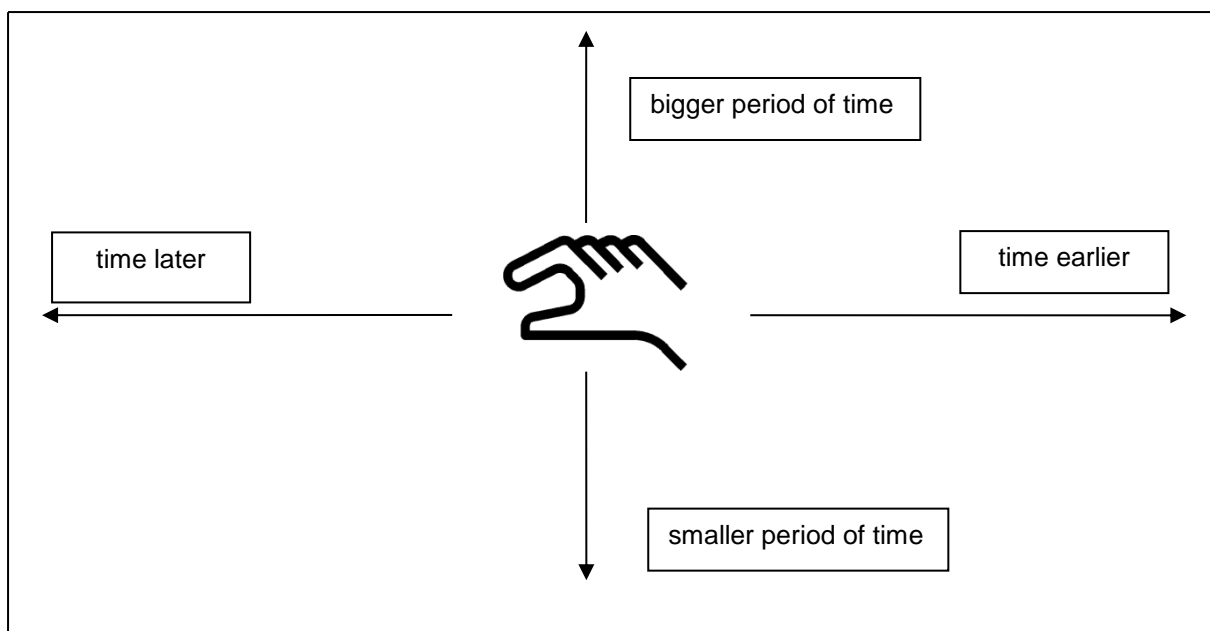

Chart

Main menu → Chart → Date description field

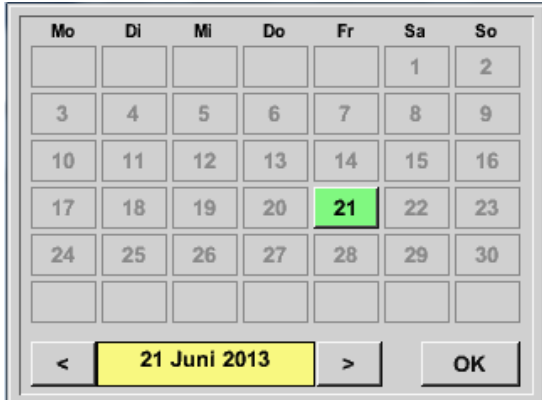

By pushing the **date** description field (center bottom) the calendar, from which the appropriate date can be selected conveniently, appears.

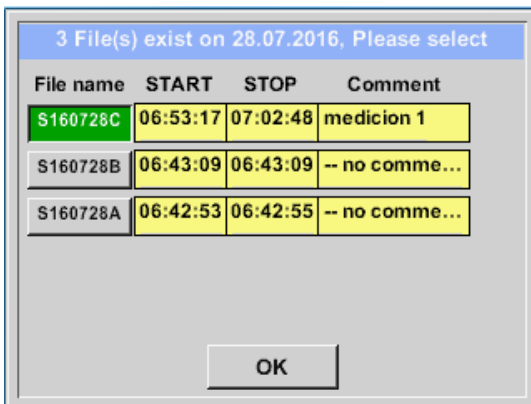

Stored measuring data can be select here by *time* (*START* and *STOP*), *Comment* and *File name* (contains English date).

Main menu → Chart → Setup

In the *Setup*, you can make up to four different y-axis labels and in addition choose a *Unit*, the grid (*min*, *max*, *step*) and several channels (*Plots*) and a *Colour*.

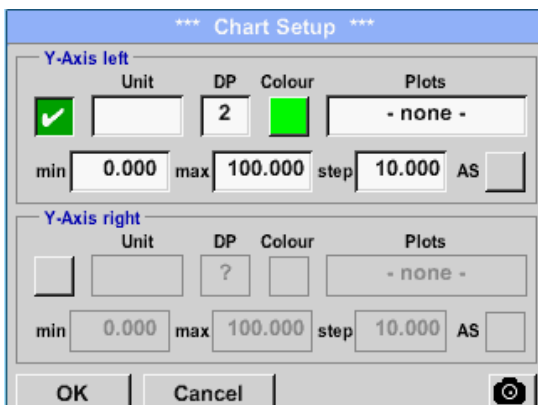

The y-axis *left* is already enabled, you can choose a color *for* it.

Remark:

Grid setting is already possible at this point, but later when a record is selected it is more reasonable!

Chart

Main menu → Chart → Setup → Unit description field



Select the *Unit* of the represented recording from the menu.



Main menu → Chart →

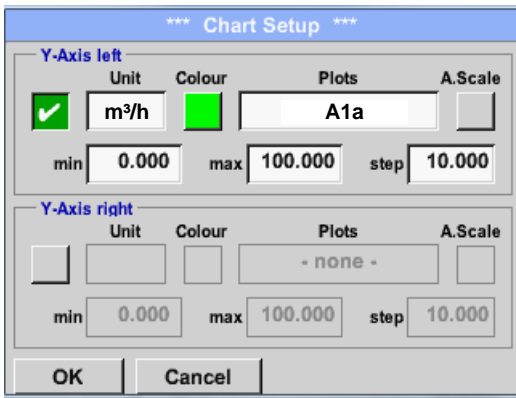

Now, the grid can be set with *min*, *max*, and *step*.

By pushing the *A.Scale*-button a calculated auto-scaling will be defined.

In the same way the remaining y-axes can be labelled!



Two different grid settings with various *Units* and *Colours*.

Chart

Hauptmenü → Grafik



13.4 Chart / Real time values

Main menu → Chart/Real time values

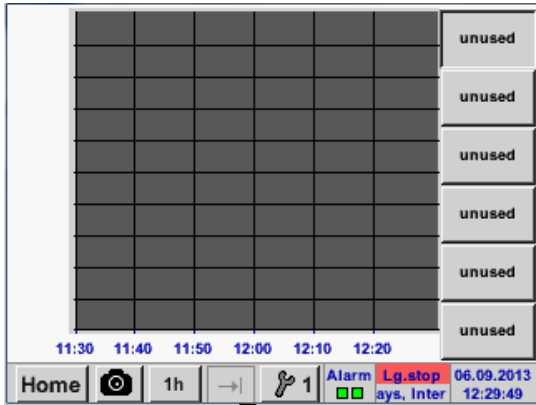

One or more channels for the recording and presentation of measured data can be selected here, such as a dew point sensor or several different sensors.

After pushing this button currently recorded measurement data in the current time range are represented.

Quick access to predefined time periods 24 h, 8 h, 1 h, 15 min and 2 min. At the push of a button, the chart for the selected time range is displayed.

Screenshot button for saving the screen on an USB Stick or SD Card.

Main menu → Chart/Real time values →  #1- #6

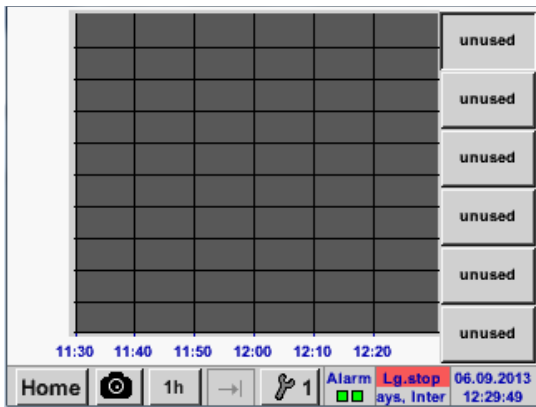

In this menu item, up to twelve channels (depending on the version of the DS 400) can be activated at the same time and viewed in *Main → Chart/Real time values*.

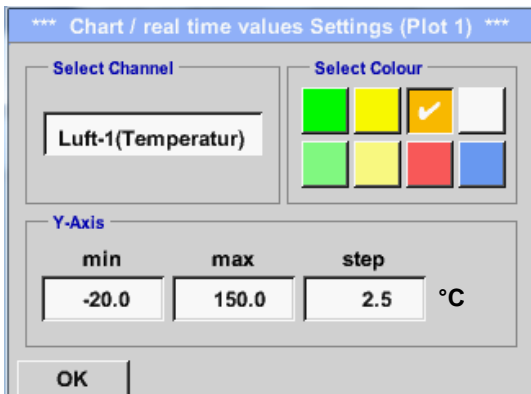

Here the channel A1 chosen.

For each channel, you can select a value to be represented in the *Chart* and one to display (*2. values*).

In addition, it can be set, like in *Main → Chart*, a *colour* and the grid (*min, max, step*) of the y-axis.

Channels

Main menu → Chart/Real time values

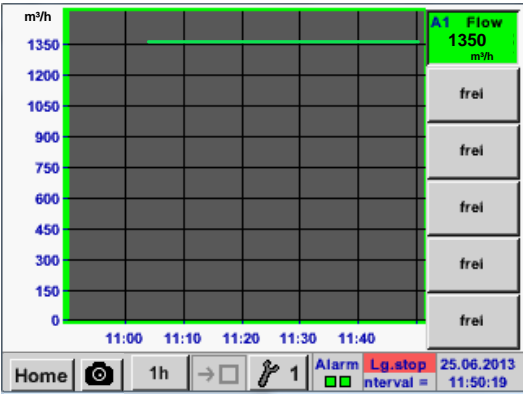

Channel A1:
Elected the flow as *Chart*

If several channels are logged, all charts will be displayed, but there is only the y-axis of the selected channel visible.

If there is no grid entered in the setup, *min* will be 0, *max* 100 and *step* 10

In the same way the remaining setups can be set!

Channels

13.5 Channels

Main menu → Channels

A1 Halle 1		A2 Halle 2	
<input checked="" type="checkbox"/> Flw	0.00 m ³ /h	<input checked="" type="checkbox"/> Flw	0.00 m ³ /h
<input checked="" type="checkbox"/> Con	90164 m ³	<input checked="" type="checkbox"/> Con	3182 m ³
Vel	0.00 m/s	Vel	0.00 m/s
Tmp	28.35 °C	Tmp	27.22 °C
B1 Halle 1		B2	
<input checked="" type="checkbox"/> DP	12.39 °Ctd	unused	
RHd	41.9674 %		
<input checked="" type="checkbox"/> Tmp	26.34 °C		
AHd	10.3904 g/m ³		
Home		Virtual Ch.	
		Alarm	Lg.stop 17.08.2012 9999 d... 04:44:02

The overview of *Real time values* shows the current measured values of all connected sensors.

Exceeds or falls below the set alarm limits, the respective measured value flashes yellow (*alarm 1*) or red (*alarm 2*).

Main menu → Channels → A1

*** Channel A1 ***			- 0.0 V
			- 0 mA
Type	VA5xx	Name	Halle 1
Record		Alarm	
<input type="checkbox"/>	Flow	0.00 m ³ /h	<input type="checkbox"/>
<input type="checkbox"/>	Comsumpt.	4589 m ³	<input type="checkbox"/>
<input type="checkbox"/>	Velocity	0.00 m/s	<input type="checkbox"/>
<input type="checkbox"/>	Temp.	25.70 °C	<input type="checkbox"/>
Back	Store	Min/Max	

Each channel can be selected and the settings viewed and checked, but **no changes** can be made here.

Remark:
Please, make changes in the *Settings!*

Real time values

13.6 Real time values

Main menu → Real time values

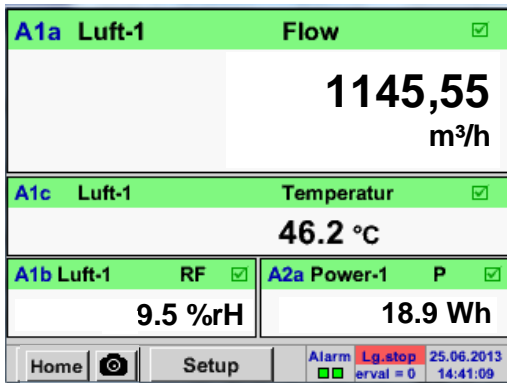

The view *Real time values* allows to display of 1 to 5 free definable measurement values.

By exceeding the upper- or lower alarm levels the respective measurement value flashes yellow for *Alarm-1* or red for *Alarm-2*.

Remark:
Changes for display settings have to be done in the *Setup* menu!

Main menu → Real time values → Setup → next Layout

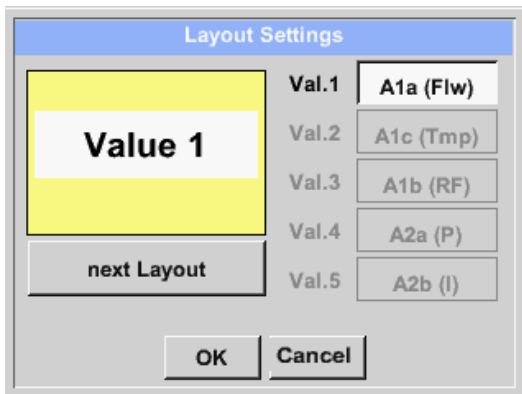

Here, by pressing *next Layout*–button it is possible to select the wanted layout.

You can choose between 6 different layouts showing 1-5 measurements. see below.

The values to be displayed could be selected in the *Val.1 to Val.5* description fields.

Different variantes :

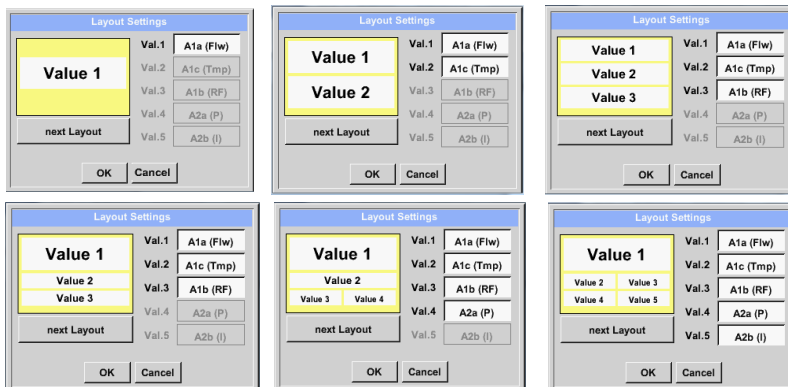

Alarm Overview

13.7 Alarm-Overview

Main menu → Alarm-Overview

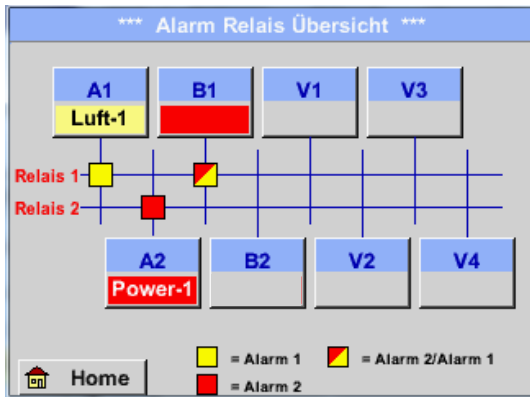

In the Alarm overview, you can immediately see whether there is an *alarm 1* or *alarm 2*. You can see also in other menu items: *Main → Real time values* and *Main → Settings → Sensor settings*. The channel name will appear yellow invers (*alarm 1*) or inverse red (*alarm 2*). In addition, you can see which relay had been set for the channel as the *alarm 1* or *alarm 2*. This is indicated by the yellow and red or red/yellow squares on the intersections between measuring channel and relay.

Here *Alarm-1* for Channel A1 and *Alarm-2* for channel A2 and B1!

Main menu → Alarm-Overview → A1

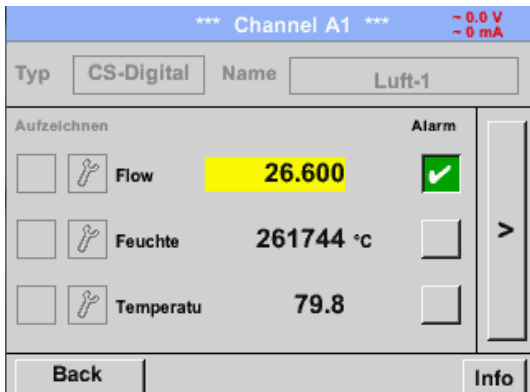

Like in *Main → Real time values*, individual channels can be selected here, to detect which and how much the value has exceeded or below the alarm range.

Remark:
The alarm parameters can be set and/or modified here.

Export / Import

13.8 Export /Import

Recorded data can be transferred to a USB stick, by using *Export/ Import*.

Main menu → Export / Import

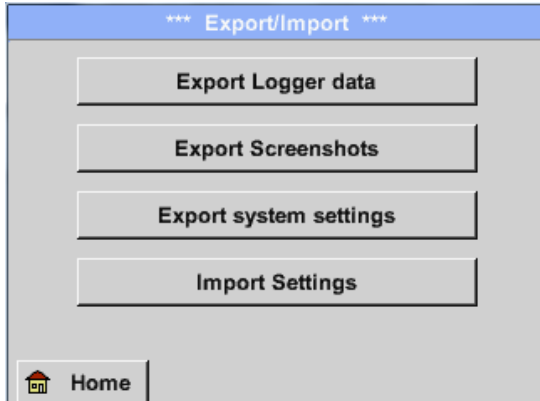

With *Export Logger data*, *Export Screenshots* and *Export system settings* the recorded measurement data, screenshots and saved settings can be transferred to a USB stick.

With *Import Settings* saved system settings could be imported from USB stick or SD card.

13.8.1 Export Logger data

Main menu → Export data → Export Logger data

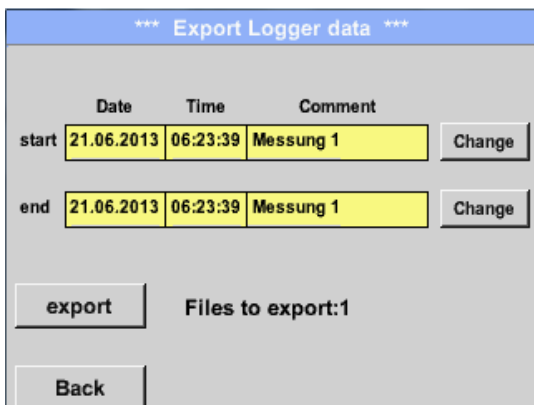

Use the *Change* buttons to adjust a period between *start* and *end*. Stored measurement data in this period are exported.

Main menu → Export data → Export Logger data → Change



The selected date is always green, and the date numbers of the Sundays are red, like in the calendar.

On days, where measurement data were recorded, the date numbers are optical highlighted.

Export / Import

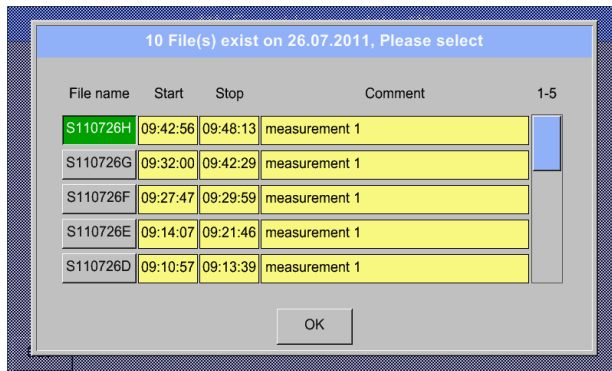

If there have been recorded several measurements on the same date, they appear after the date selection with **OK**.

Now a recording can be selected comfortable.

Main menu → Export data → Export Logger data → export

The measurement data of the selected period are exported to a USB stick.

Export / Import

13.8.2 Export System Settings

Using this function, all existing device- and sensor settings can be exported to a USB stick or SD-card. All sensor settings including recording-, alarm-, measurement resolution-, graphics-, current values- and naming-definitions are taken over.

Main menu → Export/Import → Export system settings

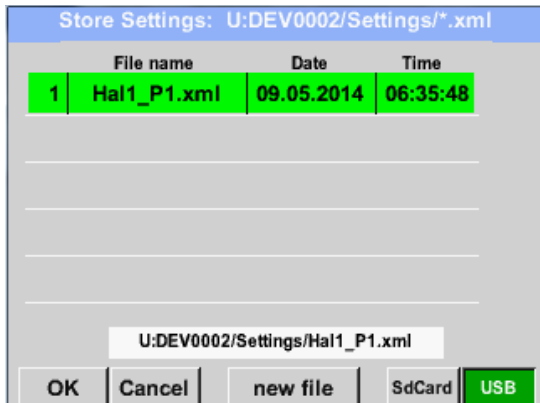

All already saved system settings will be displayed, depending on the location USB Stick or SD-Card...

Location/ path is: DEV0002/Settings

In case an existing file will be selected the content will be overwritten with the new settings after confirming with **OK** .

New File storage:

Select the location for storing by pressing the button **USB** or **SDCard**.

By choosing button **new file** a menu for inserting/defining the filename appears.

The file name length is limited **to 8 chars**.

File save/confirm with: **OK → OK**

13.8.3 Import System Settings

Using this function, stored system settings can be read back again.

All sensor settings including recording-, alarm-, measurement resolution-, graphics-, current values- and naming-definitions are taken over.

Main menu → Export/Import → Import system settings

	Dateiname	Datum	Zeit	6-10
6	v8011-2.xml	05.11.2014	16:29:02	
7	SET.xml	07.11.2014	11:40:38	
8	SET1.xml	07.11.2014	11:41:56	
9	8058.xml	07.11.2014	11:43:28	
10	8011A.xml	07.11.2014	14:02:42	

S:DEV002/Settings/V8010.xml

OK Cancel SdCard USB

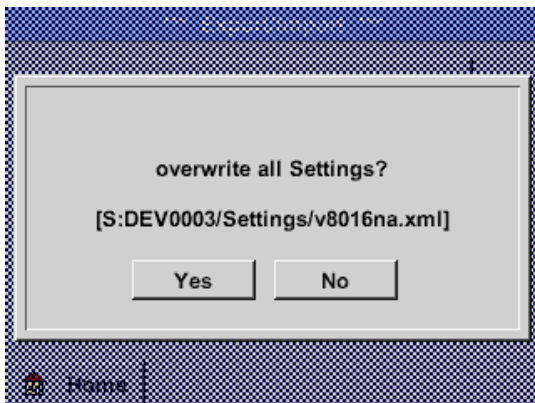

Depending on the selected location, USB stick or internal SD-card, all already stored settings will be listed.

Selection of storage location by pressing button **USB** or **SdCard**

The selected file be imported after confirming with **OK**.

To avoid any unwanted overriding's of the actual device settings it is an additional confirmation required

After importing of the new settings a reboot is required too.

For the complete takeover of the new sensor settings, they have to be activated for each channel too.

Main menu → Settings → Sensor Settings → Channel A1 ...B2

Screenshot function

13.9 Screenshot function

This function allows you to store a copy of the screen of the menus Chart, Chart / Real time Values, Channels and Real time Values to a USB-Stick or SD-Card. Mainly foreseen to save not logged data.

13.9.1 Screenshot saving

Main menu → Chart →

Main menu → Chart / real time Values →

Main menu → Channels →

Main menu → Real time Values →

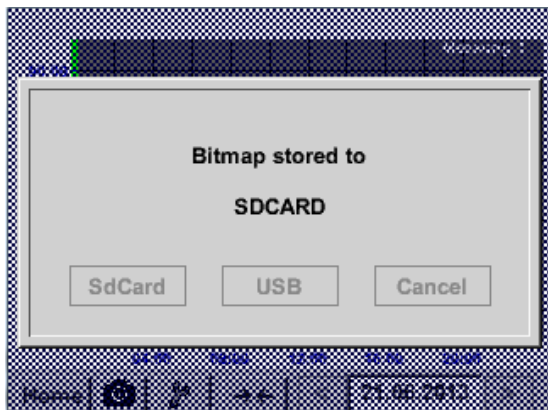
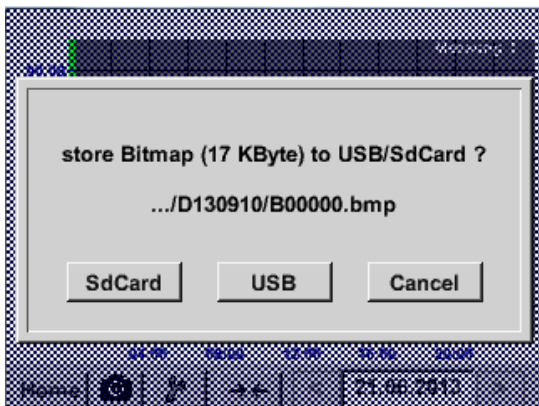

Here, the location of USB stick or SD card can be selected.

Screenshots are stored in directories defined per day and here numbered consecutively.

Directory naming; DYYMMTT
D=fix(for Date)
YY = Year
MM= Month
TT= Day

Path: DEV0002/Hostname/Bitmap

For Hostname see
[Main menu → Settings → System Status](#)

Example: first Screenshot 10. September 2013

\\DEV0002/DE-4001/Bitmap/D130910/B00000.bmp

Screenshot export

13.9.2 Screenshots export

The screenshots stored on the SD card can be exported to a USB stick

Main menu → Export Data

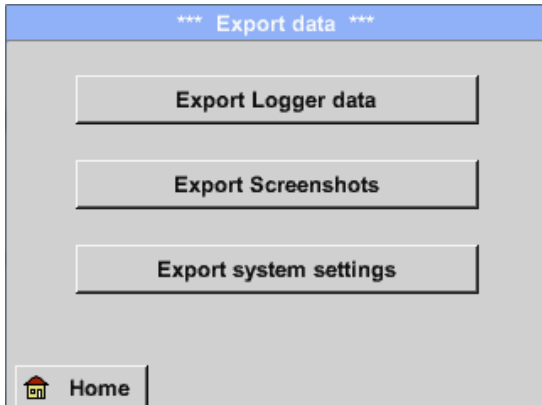

With *Export Screenshots* the recorded screenshots data can be transferred to a USB stick.

Main menu → Export Data → Export Screenshots

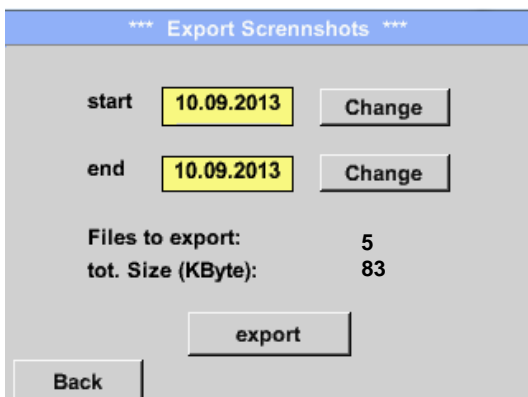

Use the *Change* buttons to adjust a period between *start* and *end*. Stored bitmaps data in this period are exported.

Main menu → Export Data → Export Screenshots → Change



The selected date is always green, and the date numbers of the Sundays are red, like in the calendar.

On days, where measurement data were recorded, the date numbers are optical highlighted.

Screenshot export

Main menu → Export Data → Export Screenshots → Export

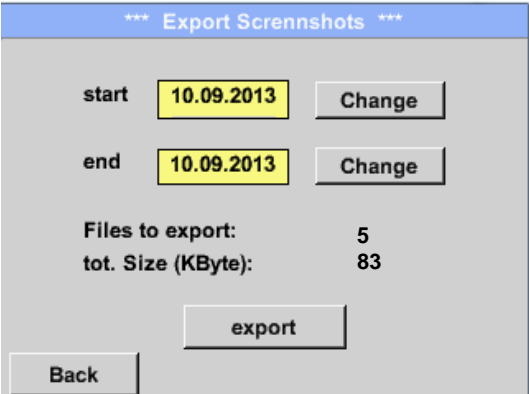

The screenshots of the selected period are exported to a USB stick.

14 Cleaning



Note:

The DS 400 has a cleaning-function which protects the display against unintentional operation in the event of cleaning measures. Please refer to [Chapter 13.2.5](#) for further information.

Cleaning of the DS 400 must be undertaken using a slightly damp (not wet) cotton cloth or one-way wipe, and mild, commercially available cleaner/soap.

For decontamination, spray the cleaner on an unused cotton cloth or one-way wipe, and wipe the component comprehensively. Perform the final drying with a clean cloth or by air drying.

In addition, the local hygiene provisions need to be observed.



Warning!

Damage possible!

A too high degree of humidity and hard and pointed objects, as well as aggressive cleaners, cause damage to the data logger and to the integrated electronic components.

Measures

- Never clean with a soaked cloth.
- Do not use aggressive cleaners.
- Do not use pointed or hard objects for cleaning.

Version: 2016/10/10, V1.30

KONFORMITÄTSERKLÄRUNG

DECLARATION OF CONFORMITY

Wir CS Instruments GmbH
 We Am Oser 28c, 24955 Harrislee

Erklären in alleiniger Verantwortung, dass das Produkt
 Declare under our sole responsibility that the product

Multi-Messgerät DS400
 Multifunction measuring instrument DS 400

den Anforderungen folgender Richtlinien entsprechen:
 We hereby declare that above mentioned components comply with requirements of the following EU directives:

Elektromagnetische Verträglichkeit Electromagnetic compatibility	2014/30/EU 2014/30/EC
Niederspannungsrichtlinie Low Voltage Directive	2014/35/EU 2014/35/EC

Angewandte harmonisierte Normen:

Harmonised standards applied:

EMV-Anforderungen EMC requirements	EN 61326-1: 2006-10 2013-07 EN 61000-3-2 : 2015-3
Sicherheitsanforderungen Safety requirements	EN 61010-1:2015-04

Anbringungsjahr der CE Kennzeichnung: 13

Year of first marking with CE Label: 13

Das Produkt ist mit dem abgebildeten Zeichen gekennzeichnet.
 The product is labled with the indicated mark.



Harrislee, den 19.04.2016



Wolfgang Blessing Geschäftsführer